

From the Department of Neurobiology, Care Sciences and Society,  
Karolinska Institutet, Stockholm, Sweden

**Genetic characterization of patients  
with frontotemporal dementia and  
amyotrophic lateral sclerosis in the  
Nordic countries**

Huei-Hsin Chiang



**Karolinska  
Institutet**

Stockholm 2012

All previously published papers were reproduced with permission from the publisher.

Published by Karolinska Institutet. Printed by Larserics Digital Print AB

© Huei-Hsin Chiang, 2012  
ISBN 978-91-7457-739-6

*To my family*



## ABSTRACT

Frontotemporal dementia (FTD) is the second most common form of neurodegenerative disease affecting people under the age of 65 years. The general symptoms are dysfunctions in behavior and/or language. Up to 50 % of FTD patients have a positive family history for dementia and mutations in the progranulin (*GRN*) gene account for 13-25 % of the familial cases. In **Paper I**, the Swedish Karolinska family with FTD was shown to have a *GRN* mutation, p.Gly35GlufsX19, which segregated with the disease. The mutation resulted in an ~50 % reduction of the *GRN* transcript. Sequencing the *GRN* cDNA resulted in only wild type sequence indicating that the mutant allele had been degraded resulting in reduced *GRN* transcript levels.

*GRN* mutations have reduced penetrance which is shown e.g. in the Karolinska family where there is a 10 years range in age at onset. The single nucleotide polymorphism (SNP) rs1990622, in linkage disequilibrium with the transmembrane protein 106B (*TMEM106B*) gene, was suggested to modify age at onset in *GRN* mutations carriers. In **Paper II**, the effect of rs1990622 on age at onset in four *GRN* mutation families, including the Karolinska family was investigated. Patients homozygous for the A allele were shown to have a significantly earlier (13 years) median age at onset compared to patients with the GA or GG genotype. To investigate possible disease mechanisms of rs1990622, the *GRN* levels in plasma and the *TMEM106B* mRNA levels in brain tissue were measured. An effect of rs1990622 genotype on plasma-*GRN* levels was detected with AA carriers having the lowest *GRN* levels and GG carriers the highest levels. However, this effect was not shown to be mediated by the modulation of *TMEM106B* transcript levels.

In **Paper III**, 100 FTD patients from Sweden were screened for *GRN* mutations and four premature stop codon mutations were identified: p.Gly35GlufsX19, p.Cys416LeufsX30, p.Tyr294X and p.Cys404X. Furthermore, the p.Cys416LeufsX30 was shown to segregate in a family with clinical heterogeneity. The serum-*GRN* levels in carriers of the three first premature stop codons showed a more than 50 % reduction compared to non-carriers. *GRN* levels and age at onset in the patient cohort varied and were thus investigated for association with rs1990622, rs5848 (located in the 3'UTR of *GRN*) and apolipoprotein E (*APOE*). Patients with the TT genotype at rs5848 had significantly lower *GRN* levels compared to CT and CC genotypes. Moreover, *APOE* ε4 positive patients had a significantly later age at onset compared to ε4 negative patients.

FTD and amyotrophic lateral sclerosis (ALS) are part of the same disease spectrum. The identification of TAR DNA binding protein 43 (TDP-43) positive neuronal inclusions in the majority of ALS and FTD patients further supported the link. To investigate the importance of *TARDBP* (the gene encoding TDP-43) mutations in Nordic ALS patients, 177 patients were sequenced in **Paper IV**. Four missense variations in three familial ALS patients were detected: p.Ala90Val, p.Gly357Arg, p.Arg361Thr and p.Ser379Pro. The three last missense variations were concluded to be possibly pathogenic since they were predicted by *in silico* analysis to be pathogenic and were absent in 200 neurologically healthy controls. The mutation frequency of *TARDBP* in Nordic ALS patient was 1.7 %. Furthermore, the p.Arg361Thr was shown to be present in a family with both ALS and FTD-ALS which further strengthens the connection between FTD and ALS.

## LIST OF PUBLICATIONS

- I. **Huei-Hsin Chiang**, Lina Rosvall, Jesper Brohede, Karin Axelman, Behnosh F. Björk, Inger Nennesmo, Tiina Robins and Caroline Graff. **Progranulin mutation causes frontotemporal dementia in the Swedish Karolinska family**. *Alzheimer's & Dementia*. 2008, 4:414-420
  
- II. Carlos Cruchaga, Caroline Graff, **Huei-Hsin Chiang**, Jun Wang, Anthony L. Hinrichs, Noah Spiegel, Sarah Bertelsen, Kevin Mayo, Joanne B. Norton, John C. Morris and Alison Goate. **Association of *TMEM106B* gene polymorphism with age at onset in granulin mutation carriers and plasma granulin protein levels**. *Archives of Neurology*. 2011, 68:581-586
  
- III. **Huei-Hsin Chiang**, Charlotte Forsell, Lena Lilius, Linn Öijerstedt, Steinunn Thordardottir, Shanmugarajan Krishnan, Marie Westerlund, Inger Nennesmo, Håkan Thonberg and Caroline Graff. **Novel progranulin mutations with reduced serum-progranulin levels in frontotemporal dementia**. *Manuscript*
  
- IV. **Huei-Hsin Chiang**, Peter M. Andersen, Ole-Bjørn Tysnes, Ole Gredal, Peter B. Christensen and Caroline Graff. **Novel *TARDBP* mutations in Nordic ALS patients**. *Journal of Human Genetics*. 2012 advance online publication doi:10.1038/jhg.2012.24

# CONTENTS

Introduction.....	1
Frontotemporal dementia.....	2
Neuropathology.....	2
FTD genetics.....	4
Microtubule-associated protein tau – <i>MAPT</i> .....	4
Chromosome 9 open reading frame 72 – <i>C9orf72</i> in FTD.....	5
Progranulin – <i>GRN</i> .....	5
Progranulin – function.....	6
Risk genes and factors.....	7
Apolipoprotein E – <i>APOE</i> .....	7
rs5848 – 3'UTR of <i>GRN</i> .....	7
rs1990622 – in linkage disequilibrium with <i>TMEM106B</i> .....	8
Amyotrophic lateral sclerosis.....	9
Neuropathology.....	9
ALS Genetics.....	9
Superoxide dismutase 1 – <i>SOD1</i> .....	9
Chromosome 9 open reading frame 72 – <i>C9orf72</i> in ALS.....	10
TAR DNA-binding protein 43 – <i>TARDBP</i> .....	10
TAR DNA-binding protein 43 – structure and function.....	10
Thesis objectives.....	12
Methodological considerations.....	13
Subjects – Patients and controls.....	13
Segregation analysis.....	13
Neuropathological examination.....	14
Genetic analysis.....	14
Sequencing.....	14
Genotyping.....	15
Mutation nomenclature.....	15
Bioinformatics.....	16
Functional analysis.....	16
Real-time PCR.....	16
GRN ELISA.....	16
Ethical considerations.....	18
Results and Discussions.....	20
Study I.....	20
Study II.....	22
Study III.....	23
Study IV.....	26
Concluding remarks and Future perspectives.....	29
Acknowledgements.....	31
References.....	33

## LIST OF ABBREVIATIONS

AD	Alzheimer disease
ALS	Amyotrophic lateral sclerosis
<i>APOE</i>	Apolipoprotein E, gene name
ApoE	Apolipoprotein E, protein name
<i>ATXN2</i>	Ataxin 2
bvFTD	Behavior variant frontotemporal dementia
<i>C9orf72</i>	Chromosome 9 open reading frame 72
cDNA	Coding deoxyribonucleic acid
<i>CFTR</i>	Cystic fibrosis transmembrane conductance regulator
<i>CHMP2B</i>	Charged multivesicular body protein 2B
DNA	Deoxyribonucleic acid
ELISA	Enzyme-linked immunosorbent assay
FALS	Familial amyotrophic lateral sclerosis
FTD	Frontotemporal dementia
FTLD	Frontotemporal lobar degeneration
<i>FUS</i>	Fused in sarcoma
<i>GRN</i>	Progranulin
GWAS	Genome wide association study
LD	Linkage disequilibrium
<i>MAPT</i>	Microtubule-associated protein tau
miR	microRNA
mRNA	Messenger ribonucleic acid
NCI	Neuronal cytoplasmic inclusion
NII	Neuronal intranuclear inclusion
PCR	Polymerase chain reaction
PNFA	Progressive non-fluent aphasia
RNA	Ribonucleic acid
<i>RPLP0</i>	Ribosomal protein, large P0
RT-PCR	Real-time polymerase chain reaction
SALS	Sporadic amyotrophic lateral sclerosis
SD	Semantic dementia
<i>SLPI</i>	Secretory leukocyte protease inhibitor
SNP	Single nucleotide polymorphism
<i>SOD1</i>	Superoxide dismutase 1
<i>TARDBP</i>	TAR DNA-binding protein 43, gene name
TDP-43	TAR DNA-binding protein 43, protein name
<i>TMEM106B</i>	Transmembrane protein 106B
TNF- $\alpha$	Tumor necrosis factor alpha
ub	Ubiquitin
UPS	Ubiquitin proteasome system
UTR	Untranslated region
<i>VCP</i>	Valosin containing protein

The gene names are in *italics*.



Abbreviations of the bases in the DNA molecules:

A	Adenine
C	Cytosine
G	Guanine
T	Thymine



# INTRODUCTION

For many neurodegenerative diseases the disease mechanisms are unknown. In order to get an insight of the underlying pathogenic mechanisms, familial forms of different neurodegenerative diseases are studied. In a family where there is a dominant inheritance pattern, the disease could be caused by a mutation in a gene. By identifying the gene and elucidating its function another piece of the disease mechanism puzzle will be obtained. However, even if the same gene is mutated the consequences can be quite different, including clinical heterogeneity and different onset ages. This simply demonstrates that there are other genetic and/or environmental factors that can modify the disease. The two neurodegenerative diseases studied in this thesis are frontotemporal dementia (FTD) and amyotrophic lateral sclerosis (ALS). They involve different parts of the nervous system and the main symptoms differ between them. However, they are recognized to be two extremes in one disease spectrum with overlapping clinical, genetic and neuropathological characteristics.

In this thesis focus has been placed on two genes, one of which is the progranulin (*GRN*) gene. *GRN* is one of the most frequently mutated genes in FTD. It is recognized that *GRN* mutations have reduced penetrance and result therefore in varied ages at onset. Different modifying genes for age at onset in FTD patients have been suggested but the evidence has not been conclusive. Three potential modifying factors have been investigated in this thesis: apolipoprotein E (*APOE*); rs5848 in the 3' untranslated region (UTR) of *GRN*; and rs1990622, a polymorphism located ~6.9 kbp from and in linkage disequilibrium (LD) with the transmembrane protein 106B gene (*TMEM106B*). Neuropathological examinations of *GRN* mutation carriers show neuronal inclusions immunoreactive for the protein TAR DNA-binding protein 43 (TDP-43). Approximately 50 % of all FTD patients have neuronal inclusions positive for TDP-43 (FTLD-TDP) which makes it the largest neuropathological subgroup in frontotemporal lobar degeneration (FTLD). There have been a few reports about FTD patients carrying mutations in *TARDBP*, the gene encoding TDP-43. However, mutations in *TARDBP* have primarily been reported in ALS patients. In addition, the majority (more than 90 %) of ALS patients also have neuronal inclusions positive for TDP-43. Thus, the TDP-43 protein ties FTD and ALS closer together. In order to determine the impact of *TARDBP* mutations in Nordic ALS patients, the *TARDBP* gene has also been studied in this thesis.

# FRONTOTEMPORAL DEMENTIA

In the literature frontotemporal dementia (FTD) and frontotemporal lobar degeneration (FTLD) have been used either to differentiate between the clinical diagnosis (FTD) and the neuropathological diagnosis (FTLD) or used as a collective term that does not differentiate between the clinical and neuropathological diagnosis (FTLD). Here FTD will be used as the umbrella term for all clinical subgroups and FTLD as the collective term for all neuropathological subgroups.

FTD is the second most common form of neurodegenerative disease mainly affecting people under the age of 65 years. It is a heterogeneous disease and there are three major clinical subgroups: behavior variant FTD (bvFTD), progressive non-fluent aphasia (PNFA) and semantic dementia (SD) <sup>1</sup>. Patients with bvFTD have primarily changes in behavior such as social disinhibition, lack of initiative and insight. Patients diagnosed as PNFA or SD have instead mainly language dysfunctions. PNFA patients have primary symptoms such as effortful speech, word retrieval difficulties, phonological and grammatical errors. Early in the disease the patient still understands relatively well the meaning of the words even if the patient has difficulties in retrieving words. In contrast, patients with SD do not understand the meaning of the words and have effortless but empty speech. Most patients have bvFTD but patients diagnosed with FTD can, as the disease progresses, develop both behavior changes and language dysfunction. In addition, some patients develop motor symptoms such as parkinsonism (16 %) or ALS (7-15 %) <sup>2</sup>. The age at onset is usually between 50-60 years and has a wide range from before 30 years to after 75 years. The mean disease duration is 6-8 years but can range from 2-20 years, which is partly due to different underlying pathologies e.g. FTD patients who also develop ALS have a mean survival of 2-3 years <sup>1-8</sup>.

## NEUROPATHOLOGY

Neuropathological examination of FTD patients typically shows bilateral or unilateral atrophy of the frontal and/or temporal lobes. Patients with bvFTD usually have symmetrical frontal and anterior temporal atrophy while patients with PNFA usually have asymmetric atrophy, involving mainly the left frontotemporal lobes and SD patients have bilateral atrophy of the anterior temporal lobe, typically left more than right. In most FTLD cases microvacuolation and neuronal loss are observed around layer II of the cerebral cortex. There are four different neuropathological subgroups of FTLD that can be distinguished using immunohistochemical methods which are described below (Figure 1) <sup>6, 9-13</sup>.

- ❖ **FTLD-TDP:** dystrophic neurites, neuronal cytoplasmic inclusions (NCIs), neuronal intranuclear inclusions (NIIs) and glial cytoplasmic inclusions immunoreactive for TDP-43 in the superficial layers of frontal and temporal neocortex and neurons of the dentate gyrus in the hippocampus. The aggregated TDP-43 protein is hyperphosphorylated, ubiquitinated (ub) and C-terminally fragmented. FTLD-TDP is the largest subgroup and accounts for ~50 % of all

FTLD cases. This group can further be classified into four histological subgroups<sup>14</sup>:

- *Type A*: numerous NCIs, dystrophic neurites and variable numbers of NIIs located predominantly in the superficial cortical layers. *GRN* mutation carriers typically have type A histology.
  - *Type B*: moderate NCIs in both superficial and deep cortical layers, few dystrophic neurites and few or no NIIs.
  - *Type C*: numerous long dystrophic neurites and few or no NCIs and NIIs, which are mostly found in the neocortex in the superficial layers.
  - *Type D*: numerous NIIs and dystrophic neurites and few NCIs in the cortex with relative sparing of the hippocampus. This histological subtype is characteristic for valosin containing protein (*VCP*) mutation carriers.
- ❖ **FTLD-tau**: neurites, NCI and glial cytoplasmic inclusions immunoreactive for ub and hyperphosphorylated microtubule associated protein tau. Different types of tau positive inclusions can be observed such as Pick bodies and neurofibrillary tangles with paired helical filaments and straight filaments in wide distribution in the cerebrum, cerebellum and brain stem.
- ❖ **FTLD-FUS**: NCI, NII, glial cytoplasmic inclusions and dystrophic neurites are negative for TDP-43 and immunoreactive for ub and fused in sarcoma (*FUS*) protein in the frontal and temporal cortex and hippocampus.
- ❖ **FTLP-UPS**: FTLD patients have NCIs immunoreactive for proteins in the ubiquitin proteasome system (UPS) such as ub and p62, and negative for tau, TDP-43 and *FUS* in the frontal and temporal lobes and dentate gyrus in the hippocampus. Thus, the identity of the ub and aggregated proteins is still unknown.

The neuropathological subgroups are present in different frequencies with FTLD-TDP being the most common: FTLD-TDP > FTLD-tau >>> FTLD-FUS > FTLD-UPS<sup>5, 6, 9-13</sup>. It is not possible to predict the neuropathological subtype based on the clinical symptoms. However, for patients with FTLD-FUS neuropathology (representing ~5 % of all FTLD cases) it has been reported that they have more severe and aggressive disease progression with younger age at onset ( $\leq 40$  years) and severe caudate atrophy

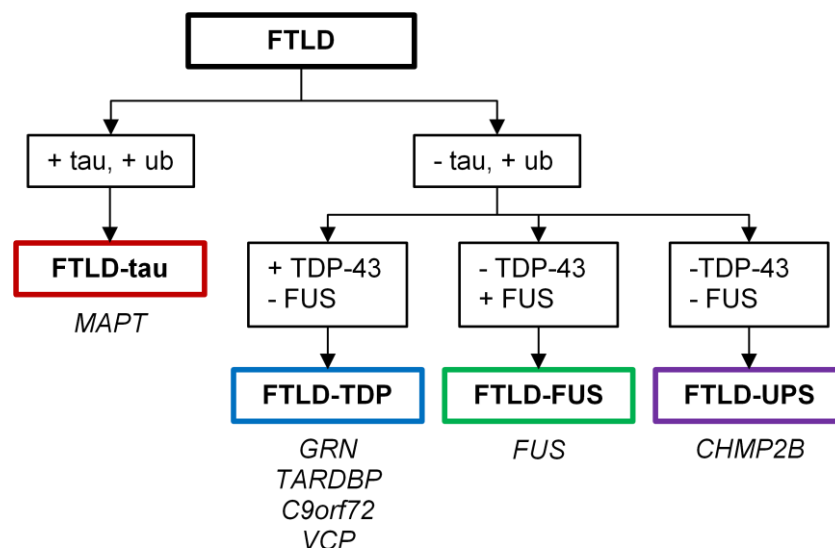

**Figure 1.** A schematic figure of the four neuropathological subgroups of FTLD and the genes associated with these subgroups in italics.

compared to the other neuropathological subgroups. Furthermore, FTLD-FUS patients usually do not have a family history for dementia<sup>13, 15</sup>.

Neuropathological examination of patients who presents both FTD and ALS usually have FTLD-TDP pathology together with TDP-43 and ub-immunoreactive inclusions in the lower motor neurons (brain stem and spinal cord)<sup>16, 17</sup>.

## FTD GENETICS

Up to 50 % of all FTD cases have a positive family history of dementia indicating that genetic factors are contributing to the etiology<sup>5, 18, 19</sup>. There have been major discoveries in FTD genetics the last five years<sup>20-27</sup>. Through linkage analysis and target gene sequencing seven genes have today been described to carry mutations that can result in FTD and FTD related syndromes:

- ❖ TAR DNA-binding protein 43 (*TARDBP*) in chromosome 1p36.22<sup>28-31</sup>
- ❖ charged multivesicular body protein 2B (*CHMP2B*) in chromosome 3p12.1<sup>32</sup>
- ❖ valosin containing protein (*VCP*) in chromosome 9p13<sup>33</sup>
- ❖ chromosome 9 open reading frame 72 (*C9orf72*) in chromosome 9p21.1<sup>22, 24</sup>
- ❖ fused in sarcoma (*FUS*) in chromosome 16p11.2<sup>34, 35</sup>
- ❖ progranulin (*GRN*) in chromosome 17q21.32<sup>20, 21</sup>
- ❖ microtubule-associated protein tau (*MAPT*) in chromosome 17q21<sup>36</sup>

FTD patients with different mutations have different histological and neuropathological subdiagnoses which suggest that there are different disease mechanisms (Figure 1). Of these seven genes, mutations in *MAPT*, *GRN* and *C9orf72* are the most common but there are no clinical symptoms that can distinguish these different mutation carriers from each other. Mutations in *VCP* and *CHMP2B* have only been detected in a few families and families with rare FTD subtypes such as Inclusion body myopathy with Paget disease of bone and frontotemporal dementia. Mutations in *TARDBP* and *FUS* were first discovered in ALS patients but were later shown to be present in a few patients with FTD and FTD-ALS.

### Microtubule-associated protein tau – *MAPT*

The *MAPT* gene was the first major gene which was shown to carry causative mutations for FTD. Mutations in *MAPT* have been detected in 5-10 % of all FTD patients and so far, 44 *MAPT* mutations have been reported. The majority is located in exons 9-13 and in intron 10 (<http://www.molgen.ua.ac.be/FTDMutations>). Mutations in exon 10 and intron 10 mainly affect the normal splicing of exon 10, which leads to the retention of exon 10 and thus more 4-repeat tau isoform. This increase of 4-repeat tau isoform will result in a shift in the ratio between 3-repeat (splicing out of exon 10) and 4-repeat (retention of exon 10) tau isoforms. The main function of the tau protein is to stabilize and promote microtubule assembly by binding to tubulin. The 4-repeat tau has stronger binding affinity to tubulin compared to 3-repeat tau<sup>37-39</sup>. The shift of 3- and 4-repeat tau ratio could have consequences in the normal dynamics of microtubule assembly. Almost all missense mutations have an effect on microtubule assembly probably by interfering with the interaction between tau and tubulin, and thereby

decreasing the ability of tau to promote microtubule assembly<sup>36, 38, 40, 41</sup>. The mean age at onset for *MAPT* mutation carriers is 55 years (range 45-65 years) and most mutation carriers develop the disease before 65 years of age. Patients carrying *MAPT* mutations usually have bvFTD and can as the disease progress, develop parkinsonism, thereby the previous name “FTD with parkinsonism linked to chromosome 17”. Neuropathological examination of *MAPT* mutation carriers reveals FTLD-tau pathology<sup>11, 38, 42-44</sup>.

### **Chromosome 9 open reading frame 72 – *C9orf72* in FTD**

Unlike *TARDBP* and *FUS*, where the majority of mutations have been identified in patients with ALS, mutations in the *C9orf72* gene have been detected in a substantial number of patients in both disease groups with a frequency of 11-25 % in familial FTD patients and 23-47 % in patients with familial ALS<sup>22, 24, 45, 46</sup>. The *C9orf72* protein is uncharacterized but has been shown to be expressed in the brain. There are two major *C9orf72* transcripts and the mutation, which is a hexanucleotide repeat (GGGGCC) expansion, is located in the promoter region in one of the major transcripts and in the other major transcript the expansion is located in the intronic region. A minimum of 60 repeats are suggested to be pathogenic while  $\leq 25$  repeats are considered to be non-pathogenic<sup>22, 24, 45-47</sup>. There have been reports indicating that *C9orf72* mutation carriers in each following generation have an even earlier age at onset suggesting that there is anticipation. However, this has not been shown in all investigated families<sup>24, 47, 48</sup>. Furthermore, the penetrance of the *C9orf72* mutations is reduced but is estimated to be ~100 % at the age of 80 years<sup>46</sup>. The disease mechanism of *C9orf72* mutations is being investigated and it has been shown that the *C9orf72* transcript carrying the pathogenic expansion in its promoter region cannot be detected by real-time polymerase chain reaction (RT-PCR). *In vitro* models have demonstrated that the other major transcript with the hexanucleotide repeat expansion in its intronic region, forms ribonucleic acid (RNA) foci in the nucleus<sup>22, 45</sup>. The majority of patients with *C9orf72* mutations have bvFTD and 27-36 % of the patients also have ALS<sup>22, 24, 45, 46</sup>. Neuropathological examination of *C9orf72* mutation carriers reveals primarily FTLD-TDP type B pathology in the neocortex and hippocampus and in those cases where the patient has both FTD and ALS, TDP-43 inclusions in the lower motor neurons are detected. However, there are NCI that are not immunoreactive for TDP-43 indicating that there are other unidentified aggregated proteins<sup>45, 47</sup>.

### **Progranulin – *GRN***

The FTD gene that has been investigated in this thesis is *GRN*. *GRN* mutations are present in 5-10 % of all FTD cases and 13-25 % of the familial cases<sup>18, 44, 49</sup>. To date, 69 mutations have been reported in *GRN* and they have been detected in all coding exons except for exon 13 (<http://www.molgen.ua.ac.be/FTDMutations>). The types of mutations detected are foremost nonsense, frame shift (deletions and insertions) and substitutions (missense and mutations affecting splice sites) but also deletions of the whole gene have been reported in two families<sup>50, 51</sup>. The majority of the detected mutations results in a premature stop codon and it is hypothesized that the *GRN* messenger RNA (mRNA) carrying the mutation is degraded by nonsense mediated decay while the wild type *GRN* mRNA becomes translated. Thus, these null mutations would lead to an ~50 % reduction of functional *GRN* protein which can be measured in e.g. serum, plasma and cerebrospinal fluid<sup>52-55</sup>. The mean age at onset for *GRN*

mutation carriers is around 60 years (ranging from 35 to 89 years) which is generally later compared to *MAPT* mutation carriers. *GRN* mutations have reduced penetrance and it is estimated that ~90 % of the mutation carriers are symptomatic at the age of 70 years. The majority of *GRN* mutation carriers have bvFTD and many of the patients also develop parkinsonism, and symptoms such as hallucinations and delusions are frequently reported. In addition, patients with other clinical diagnoses have been reported to carry *GRN* mutations such as corticobasal syndrome and Alzheimer disease (AD). However, these diagnoses have not been confirmed by neuropathological examination<sup>5, 42-44, 49</sup>.

### *Progranulin – function*

*GRN* is an ~8 kbp gene, consisting of 13 exons (Figure 2). It encodes a 593 amino acid, 88 kDa secreted glycoprotein. *GRN* is mainly expressed in cells with high mitotic activity such as epithelial cells in the intestinal crypt and epidermal keratinocytes of the skin, and also in immunological tissue such as the spleen and lymph nodes<sup>56</sup>. In the central nervous system *GRN* is expressed in microglia and neurons in e.g. hippocampus, Purkinje cells of the cerebellum and motor neurons<sup>56, 57</sup>. *GRN* can be cleaved by extracellular proteases such as elastase to smaller 6 kDa peptides called granulins (granulin A-G). The protein secretory leukocyte protease inhibitor (SLPI) can bind to *GRN* and prevents it from getting cleaved by elastase<sup>58</sup>. Furthermore, it has been shown that *GRN* can bind to the transmembrane protein sortilin, which can regulate the extracellular levels of *GRN* through endocytosis<sup>59</sup>.

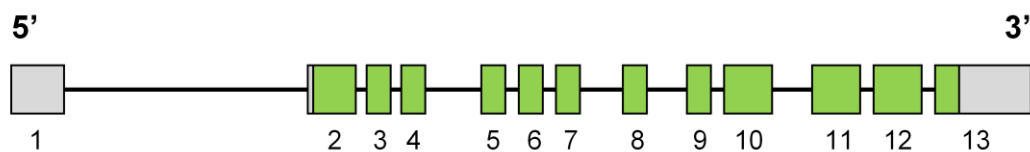

**Figure 2.** Schematic figure of the progranulin gene with its 13 exons. The grey boxes indicate the non-coding regions of the gene and the green boxes are the coding regions.

*GRN* has been shown to be involved in e.g. tumorigenesis, wound repair, development and inflammation. Progranulin can in *in vitro* models stimulate processes that are important in tumor formation such as proliferation and inhibition of apoptosis. In order to aid the wound healing process, *GRN* expression is increased in fibroblasts and endothelial cells in the wound, which under normal conditions express little or no *GRN*. Furthermore, it seems that the precursor *GRN* protein and the granulin peptides have opposite functions in inflammation. *GRN* has mainly anti-inflammatory action where it can bind the receptor tumor necrosis factor- $\alpha$  (TNF- $\alpha$ ) and inhibit the receptor's downstream signaling pathways. The granulin peptides have pro-inflammatory action such as stimulation of interleukin-8 secretion<sup>57, 60</sup>. To investigate the function of *GRN* *in vivo*, transgenic mouse models have been generated. The role of *GRN* in inflammation response is further demonstrated in *Grn*<sup>-/-</sup> mice that have increased microgliosis and astrogliosis, and delayed recovery after bacterial infection<sup>61-64</sup>. *GRN* and granulin-E have been shown to promote cell survival and neurite outgrowth in cultured rat cortical neurons and spinal cord motor neurons<sup>65</sup>. Knocking down *GRN* mRNA expression in primary cultured mouse cortical neurons with silencing RNA resulted in sensitization of cells to stimuli, which promoted cell death<sup>66</sup>.



Heterozygous knockout mice ( $Grn^{+/-}$ ) have no phenotype but homozygous knockout mice ( $Grn^{-/-}$ ) have in some studies shown aggression, anxiety and dysfunctional social interactions<sup>62, 63, 67</sup>. Unlike FTD patients, no general atrophy of the cerebrum has been observed in the  $Grn^{-/-}$  mice<sup>61, 62, 64</sup>. Furthermore, the majority of the mouse models do not have TDP-43 immunoreactive neuronal inclusions<sup>61-64</sup>. However, one mouse model showed ub-immunoreactive inclusions that co-localized with lipofuscin granules. Lipofuscin is a marker for cellular aging in postmitotic cells e.g. neurons, and the increased lipofuscin granules in  $Grn^{-/-}$  mice indicates that their neurons age faster than wild type mice<sup>61</sup>.

## Risk genes and factors

There are no known environmental risk factors for FTD, only genetic risk factors have been reported<sup>5, 68</sup>. In this thesis, three potential genetic factors have been investigated: *APOE*, rs5848 located in the 3'UTR of *GRN* and rs1990622 in linkage disequilibrium with *TMEM106B*.

### *Apolipoprotein E – APOE*

The *APOE* gene located on chromosome 19q13.2 encodes a 299 amino acid long protein which has three major isoforms:  $\epsilon 2$ ,  $\epsilon 3$  and  $\epsilon 4$ . Each isoform shows differences in protein structure and biological function<sup>69</sup>. The ApoE protein has for instance a lipid binding domain and the different isoforms bind to lipids with different affinity, making it more or less efficient as a lipid transporter. In the central nervous system ApoE is a major transporter of lipids. In AD, the gene allele *APOE*  $\epsilon 4$  is a recognized risk factor but its role in FTD is unclear<sup>70, 71</sup>. The evidence for *APOE* as a risk factor for FTD has been inconclusive with reports on a positive association where  $\epsilon 4$  allele carriers had a lower age at onset and reports on no association with age at onset<sup>72-78</sup>. Since, *GRN* mutations have reduced penetrance there maybe genetic modifying factors for age at onset in mutation carriers. Investigating *APOE* in *GRN* mutation carriers gave a surprising result: *GRN* mutation carriers with *APOE*  $\epsilon 4$  had a later age at onset compared to  $\epsilon 3$  patients<sup>42, 79</sup>. However, this effect has not been observed in all studies<sup>21, 80</sup>.

### *rs5848 – 3'UTR of GRN*

In 2008 a significant association was found between FTLD-TDP patients and rs5848, a SNP located in the 3'UTR of *GRN*. The frequency of patients homozygous for the minor allele T was significantly higher compared to control individuals. Furthermore, it was estimated that patients with the TT genotype of rs5848 had a 3.2 fold increased risk of developing FTLD-TDP compared to CC individuals. When the authors investigated possible explanations for the association it was found that rs5848 was located in a predicted binding site for the microRNA miR-659. MicroRNAs are small non-coding RNA molecules that can bind to mRNA and modulate the target mRNA's translation. It was predicted that miR-659 would bind to this region more strongly in the presence of a T allele compared to C allele and thus be a more efficient inhibitor of *GRN* translation. Western blot analysis and enzyme-linked immunosorbent assays (ELISA) performed on brain tissue from patients with FTLD-TDP neuropathology demonstrated that rs5848 TT patients had significantly lower GRN protein levels compared with

rs5848 CC genotype patients. *In vitro* studies also showed that miR-659 could regulate GRN levels<sup>81</sup>. Although, the association between the rs5848 TT genotype and increased risk for developing FTD has not been replicated in other studies<sup>82, 83</sup>, one study showed that FTD patients homozygous for the T allele had lower plasma-GRN levels compared to CC carriers<sup>84</sup>. Thus, it is possible that FTD patients homozygous for the T allele have an increased risk for FTD and this effect maybe due to the modulation of GRN protein concentrations.

#### *rs1990622 – in linkage disequilibrium with TMEM106B*

Genome wide association studies (GWAS) on FTD have been considered risky since FTD is a very heterogeneous disease with different clinical, genetic and neuropathological subgroups. Finding common risk factors for all FTD subtypes using GWAS would therefore be difficult. However, in 2010 the first and only FTD-GWAS was published<sup>85</sup>. In order to get a homogenous patient cohort the authors only included patients with the neuropathological diagnosis FTLD-TDP. The patient cohort consisted of 515 FTLD-TDP patients, 89 of whom carried *GRN* mutations. The analysis resulted in the detection of three SNPs, located within a 68 kbp region on chromosome 7p21.3. The SNPs were in linkage disequilibrium (LD) with the gene transmembrane protein 106B (*TMEM106B*), which encoded an uncharacterized 274 amino acid protein. The top SNP was rs1990622 ( $p = 2 \times 10^{-4}$ ) with the major allele T being the risk allele. The significant association was detected both in patients with and without *GRN* mutations. Furthermore, the T allele was associated with higher levels of *TMEM106B* mRNA expression in lymphoblastoid cell lines and frontal cortex, indicating that rs1990622 or other SNPs in LD with rs1990622 could regulate the expression. The increased *TMEM106B* expression levels were highest in the *GRN* mutation carrier group. Thus, *GRN* mutations might act upstream of *TMEM106B* expression and together with the risk allele T modify the disease progression<sup>85</sup>. In 2011 there was an attempt to replicate the top SNPs from the FTD-GWAS but failed<sup>86</sup>. The authors suggested that the reason could be due to the heterogeneous patient cohort. In the replication study, clinical FTD patients were included indicating that other neuropathological subgroups such as FTLD-tau were most likely present. Therefore, it could mean that the findings from the first FTD-GWAS were specific for FTLD-TDP patients. Finally, studies investigating the association between the top SNP rs1990622 and age at onset in *GRN* mutation carriers have been inconclusive<sup>52, 85, 87, 88</sup>.

## AMYOTROPHIC LATERAL SCLEROSIS

Amyotrophic lateral sclerosis (ALS) is the most common form of motor neuron disease where the upper (cortex) and lower (brain stem and spinal cord) motor neurons progressively degenerate. Symptoms of upper motor neuron degeneration are for example muscular spasticity and hyperreflexia, and lower motor symptoms are for example muscular atrophy and fasciculations<sup>89, 90</sup>. ALS patients can either have spinal onset i.e. symptoms starting in the upper or lower limb, or bulbar onset where the patients develop dysarthria and dysphagia. The age at onset is generally 55-65 years for sporadic ALS (SALS). However, in patients with a positive family history (FALS) the age at onset is usually 10 years earlier. Except for age at onset, there are no clinical differences between SALS and FALS. The progression of the disease is often rapid and the patient usually dies within 2-5 years after disease onset due to respiratory failure or pneumonia<sup>89-91</sup>. Furthermore, up to 50 % of the ALS patients also have cognitive dysfunctions and 5-15 % of ALS patients develops FTD<sup>3, 89-93</sup>.

### NEUROPATHOLOGY

Neuropathological findings characteristic for ALS are neuronal cytoplasmic inclusions (NCIs) in the remaining motor neurons: bunina bodies, skein-like inclusions and Lewy-body like inclusions<sup>16, 17, 90, 94</sup>.

- ❖ Bunina bodies: eosinophilic granular NCIs that are immunoreactive for cystatin C and transferring but not for ub.
- ❖ Skein-like inclusions: filamentous NCIs which are immunoreactive for ub and TDP-43.
- ❖ Lewy-body like inclusions: compact and spherical inclusions immunoreactive for ub and TDP-43.

The majority of ALS patients (>90 %) have TDP-43 positive neuropathology. Bunina bodies, skein-like inclusions and Lewy-body like inclusions are found in both SALS and FALS<sup>90, 94</sup>. Furthermore, patients with mutations in the superoxide dismutase 1 (*SOD1*) gene have inclusions consisting of SOD1 protein and the majority of ALS patients with *SOD1* mutations do not have TDP-43 pathology suggesting that these two different pathologies have different etiologies<sup>94-97</sup>.

### ALS GENETICS

The majority of ALS patients seem to be sporadic (SALS) and ~10 % have a positive family history. From meta-analysis data on monozygotic and dizygotic twin studies the heritability of SALS was estimated to be 0.61 i.e. 61 % of SALS is explained by genetics and 39 % is explained by environmental factors<sup>98</sup>. The genetics of ALS is complex with more than 10 reported causative genes e.g. *SOD1*<sup>99</sup> and *C9orf72*, and several suggested susceptibility genes e.g. *APOE* and ataxin-2 (*ATXN2*)<sup>89-91, 100-104</sup>.

#### Superoxide dismutase 1 – *SOD1*

Before the identification of mutations in *C9orf72*, the mutation frequency of *SOD1* was the highest in ALS accounting for 10-20 % of all FALS cases and 2-7 % of SALS<sup>89-91</sup>.

<sup>100, 101</sup>. To date, 165 dominant and recessive mutations have been reported in all of its five exons and the majority of the reported mutations are missense mutations with reduced penetrance (<http://alsod.iop.kcl.ac.uk>). *SOD1* mutation carriers have primarily spinal onset with a mean age at onset at 55 years <sup>105</sup>. The gene is located on chromosome 21q22.11 and encodes a 154 amino acid cytosolic enzyme. Together with the ions  $\text{Cu}^{2+}$  and  $\text{Zn}^{2+}$ , *SOD1* forms a subunit which in a pair makes up the active *SOD1* homodimer enzyme. Its function is to catalyze the reduction of the superoxide anion to  $\text{O}_2$  and  $\text{H}_2\text{O}_2$ . The hypothesized disease mechanism for *SOD1* mutations is that the *SOD1* protein gains cytotoxic function but of what kind is currently unknown <sup>104, 106</sup>.

### Chromosome 9 open reading frame 72 – *C9orf72* in ALS

Approximately 23-47 % of all FALS and 4-21 % of SALS patients have mutations in the *C9orf72* gene. In patients with both FTD and ALS, the mutation frequency was almost up to 60 %. *C9orf72* mutation carriers have more often spinal onset than bulbar onset. However, bulbar onset is more frequent in *C9orf72* mutation carriers compared to *SOD1* mutation carriers. Furthermore, the mean age at onset is ~57 years (range 27-80 years) which is similar to patients carrying *SOD1* mutations. Neuropathological examination on ALS patients with *C9orf72* mutations show TDP-43 immunoreactive inclusions in the brain and spinal cord but not all ub-immunoreactive inclusions stain positive for TDP-43 <sup>22, 24, 45, 46</sup>.

### TAR DNA-binding protein 43 – *TARDBP*

We have investigated the *TARDBP* gene which encodes the protein found to be aggregated in the motor neurons in the majority of ALS patients called TDP-43 <sup>16, 17</sup>. Mutations in the *TARDBP* gene have reduced penetrance and are reported in 4-6 % of the patients with FALS and 0-2 % in SALS <sup>23, 25, 104</sup>. So far, more than 40 dominant mutations have been reported and the majority are missense mutations located in the coding region of exon 6 (<http://alsod.iop.kcl.ac.uk>, <http://bioinfo.hr/pro-mine/>). The majority of mutation carriers have spinal onset with the mean age at onset at 54 years <sup>105</sup>. However, the disease mechanism for the mutations has not been determined.

#### *TAR DNA-binding protein 43 – structure and function*

TAR DNA binding protein 43 (*TARDBP*) is an ~13 kbp gene consisting of six exons (Figure 3). It encodes a ubiquitously expressed 414 amino acid, 43 kDa nuclear protein that can bind to DNA and RNA. At the N-terminal of TDP-43 lies the nuclear localization signal and at its C-terminal lies the nuclear export signal. Its function is not completely understood but has been shown to be important in RNA metabolism e.g. in mRNA splicing, stability and transport. TDP-43 has e.g. been shown to regulate the splicing of exon 9 in the cystic fibrosis transmembrane conductance regulator gene

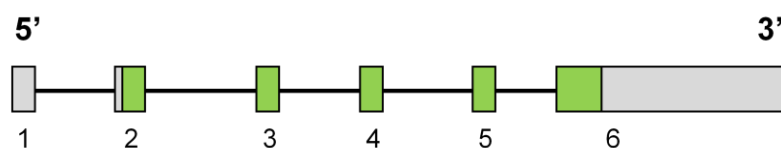

**Figure 3.** Schematic figure of the *TARDBP* gene with its 6 exons. The grey boxes indicate the non-coding regions of the gene and the green boxes are the coding regions.

(*CFTR*) and stabilize the low molecular weight neurofilament mRNA<sup>107-110</sup>. The majority of normal endogenous TDP-43 is localized in the nucleus but there is a continuous shuttling of the protein between the nucleus and cytoplasm. However, in the pathological state the protein is instead translocated to the cytoplasm where it aggregates. The discovery of neuronal inclusions positive for TDP-43 was first made in FTLD and ALS<sup>16,17</sup>. Soon after, TDP-43 was also detected in other neurodegenerative disease such as AD (23-42 %) and Lewy body dementia (45-52 %) <sup>111-113</sup>. In immunoblot analyses using TDP-43 antibodies, two bands at ~25 kDa and ~35 kDa can be detected in the brain and spinal cord tissue extracts of FTLD-TDP and ALS patients and not in neurological healthy individuals<sup>16,17</sup>. These TDP-43 positive fragments can also be detected in transgenic mice that over-express human wild type TDP-43 or TDP-43 with mutations<sup>114-117</sup>. It is suggested that the C-terminal cleavage of TDP-43 is mediated by caspases, in particular caspase-3<sup>66,118-120</sup>. The pathologically aggregated TDP-43 has been shown to be not only ubiquitinated but also abnormally phosphorylated at the C-terminal positions Ser409/Ser410. There are now commercially available antibodies that target these phosphorylated sites and thus only bind to the pathological and aggregated forms of TDP-43<sup>121</sup>.

Different transgenic mouse models have been generated such as mice expressing human *TARDBP* with known mutations and mice over-expressing human *TARDBP*. These mice developed severe motor phenotypes similar to ALS patients such as weakness, spasticity, reduced spontaneous movements and shorter survival compared to wild type mice. Other features that the mouse models shared were that the severity of the symptoms, astrogliosis, microgliosis and neurodegeneration depended on the TDP-43 expression levels i.e. it was dose-dependent. Ub-positive staining has been found in specific neurons such as the cortical neurons in layer V and in the motor neurons of the ventral horn in the spinal cord. The ub-positive cytoplasmic inclusions were in some transgenic mouse models also positive for TDP-43 but the majority was not<sup>114-117</sup>. However, it has also been shown that over-expression of human *TARDBP*, with or without mutations, leads to down regulation of the endogenous mouse TDP-43 protein. This suggests that it might be possible that the loss of endogenous TDP-43 contributes to the neurodegeneration<sup>114</sup>. The importance of endogenous TDP-43 was shown by the fact that knocking out the mouse *Tardbp* gene was embryonic lethal<sup>122</sup>.

Since FTD patients with *GRN* mutations have FTLD-TDP neuropathology it indicates that there is a connection between these genes. Various *in vitro* studies using primary cortical mouse neurons with either *Grn* knockout or knockdown techniques demonstrated that reduced *Grn* expression can lead to TDP-43 redistribution from the nucleus to the cytoplasm<sup>66,119,120</sup>. In some models, the reduction in *Grn* levels resulted in increased caspase activity. However, caspase activity was not necessary for the formation of TDP-43 aggregates<sup>66,119,120</sup>. Furthermore, not all studies showed that the reduction of *Grn* levels was enough to induce caspase-mediated cleavage of TDP-43<sup>118</sup>.

## THESIS OBJECTIVES

The overall aim of this thesis was to perform genetic studies in two diseases that belong to the same disease spectrum, FTD and ALS, by investigating the mutation frequency and possible modifying effects of candidate genes.

### **Paper I**

The aim of this study was to investigate if the Swedish Karolinska family carried a mutation in the *GRN* gene which causes dominantly inherited FTD.

### **Paper II**

The aim of this study was to investigate if the SNP rs1990622 in LD with the *TMEM106B* gene can modify the age at onset for *GRN* mutation carriers and to investigate possible functional effects of the SNP.

### **Paper III**

The aim of this study was to investigate the mutation frequency of the *GRN* gene among FTD patients from Sweden. Additional aims were to use serum to evaluate if the detected *GRN* variations are pathogenic and if the three potential modifying factors rs5848, rs1990622 and *APOE* are associated with age at onset and/or serum-GRN levels in FTD patients.

### **Paper IV**

The aim of this study was to investigate the *TARDBP* mutation frequency among Nordic ALS patients.

## METHODOLOGICAL CONSIDERATIONS

A detailed description of materials and methods can be found in Papers I-IV. Here follows a summary of the main materials and methods used.

### SUBJECTS – PATIENTS AND CONTROLS

The FTD patients included in Papers I-III were recruited from Karolinska University Hospital, Department of Geriatric medicine. The diagnostic criteria for FTD was according to Neary et al. 1998 <sup>1</sup>. In Paper III patients diagnosed as unspecified dementia with frontal signs were also included. Patients given this diagnosis were patients who displayed heterogeneous clinical symptoms which did not correspond to a single dementia diagnosis. Usually these patients had memory difficulties, which would suggest an AD diagnosis, and predominant behavioral problems which would indicate an FTD diagnosis. Furthermore, patients with a neuropathological diagnosis and tau negative FTLD were prioritized in the selection of the patient cohort in Paper III.

The ALS patients included in Paper IV were recruited from the Umeå University hospital and were diagnosed according to El Escorial criteria <sup>123</sup>. Patients with a positive family history for ALS or FTD were prioritized in the selection of the patient cohort.

Additional deoxyribonucleic acid (DNA) from blood-relatives was available for segregation analysis and for haplotype analysis in some cases (Paper I-IV).

The control cohort consisted of neurologically healthy individuals with mini mental state examination scores  $\geq 28$  and was recruited from the Swedish National study on Aging and Care (<http://www.snac-k.se>).

Informed consent was obtained for all participants. Approved local ethical permissions were obtained for all studies.

### SEGREGATION ANALYSIS

A method to find out if a detected genetic variation is pathogenic is to perform a segregation analysis. Here DNA from additional family members, preferably both affected and healthy family members, are needed in order to see if the variation co-segregates with the disease i.e. the variation should be present only in affected family members and not in healthy individuals. However, it is important to keep in mind that the penetrance for *GRN* and *TARDBP* mutations is reduced i.e. a child to a healthy parent can inherit the mutation and develop the disease. Furthermore, it is also possible that the mutation is not present in an affected family member due to the fact that they have a different clinical diagnosis or another etiology for the disease e.g. in Paper III there was a family with diverse clinical diagnoses where one individual who was diagnosed with multiple sclerosis did not carry the mutation while the family members diagnosed as AD, FTD and vascular dementia carried the mutation. Another important aspect is the presence of phenocopies i.e. a family member showing the same clinical symptoms as its mutation carrying relative but the disease is instead caused by other

unknown genetic or environmental factors. This could be the case for a patient diagnosed with FTD after several years of major depressive disease in Paper III.

## NEUROPATHOLOGICAL EXAMINATION

It is not always easy to give the “right” diagnosis since many patients do not present the typical “text book” symptoms of a disease. In the case of FTD where the age at onset is generally below the age of 65 years and where behavioral changes can be interpreted as a psychiatric disorder, the patient can be misdiagnosed. Furthermore, during the course of the disease, the FTD patient can be mistaken for AD because some patients may develop memory problems. In order to get a definite diagnosis neuropathological examination is necessary. In Paper III, a *GRN* mutation carrier received the clinical diagnosis AD but was re-diagnosed to FTLD-TDP after the neuropathological examination. The neuropathological subgroup FTLD-TDP can be further divided into four subtypes. In Papers I and III neuropathological examinations were performed on *GRN* mutation carriers which included immunohistochemistry for TDP-43. Recently, there was an update and harmonization of FTLD-TDP subtype classification. Previously there were two different classification systems and in Paper I and Paper II the mutation carriers were all classified as type 3<sup>9</sup> which now corresponds to type A using the new classification system<sup>14</sup>.

## GENETIC ANALYSIS

### Sequencing

Pathogenic mutations are often located in the coding regions of a gene where they can affect the sequence, structure, function and/or expression of the encoded protein. Furthermore, the donor and acceptor sites for splicing are located at the intron-exon boundaries, making this region an important target for mutation screening. We have therefore targeted the exons and at least 20 intronic bases at the intron-exon boundaries for mutation screening of *GRN* and *TARDBP* (Paper I, III and IV). In order to obtain the sequence, the targeted regions (usually 300-500 bp) were amplified with AmpliTaq Gold® PCR master mix (ABI, Branchburg, NJ, USA). However, to amplify exons 5 and 6 in *GRN* addition of Q-solution (Qiagen, Hilden, Germany) (Paper I) or the use of AmpliTaq® Gold 360 master mix (ABI, Foster City, CA, USA) (Paper III) was needed due to the high GC content of the sequence. The target regions were sequenced using BigDye® Terminator v.3.1 Cycle Sequencing Kit (ABI, Austin, TX, USA) and then analyzed on an ABI 3100 genetic analyzer in our laboratory (Figure 4).

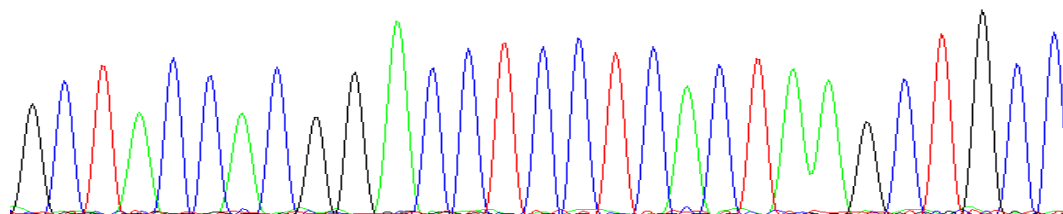

**Figure 4.** Electropherogram of the DNA sequence. The different peak colors of the electropherogram represent the different nucleotides. Here the black peak represents G, blue peak C, red peak T and green peak A.



## Genotyping

The genotype of the SNPs and microsatellites were obtained using three different methods:

- ❖ The SNPs were genotyped using either sequencing or commercially available TaqMan<sup>®</sup> SNP genotyping assays (ABI, Foster City, CA, USA).
  - When sequencing you automatically get information about SNP genotypes located in the target regions. In Paper III this method was useful since all of the studied SNPs in *GRN* could be obtained at the same time as the gene sequence.
  - TaqMan assay is a much faster method for genotyping compared to sequencing, especially if you are only interested in one specific SNP (e.g. rs1990622 in Paper II and III). The results were analyzed on ABI 7500 Fast real-time PCR system.
- ❖ Microsatellite markers are short runs (usually <100 bp) of tandem repeats of a few bases, usually 1-4 bp. The number of repeats for a specific microsatellite varies and therefore the numbers of alleles for the microsatellites are usually more than two. The number of repeats i.e. the length of the microsatellites can be determined by fragment length analysis using an ABI 3100 genetic analyzer. In Paper III, microsatellites flanking the *GRN* gene were genotyped in order to determine kinship between families with the same *GRN* mutation. The greater the shared disease haplotype are between two families the closer they are related. However, in Paper III we could not determine if the disease haplotype in the families that carried the same mutation were identical by state (have the same mutation but are not related) or by descent (have the same mutation because they have a common ancestor).

## MUTATION NOMENCLATURE

The nomenclature of the detected genetic variations can be named depending on which level you want to describe the mutation on and the numbering is relative to a reference sequence:

- g. = indicates that the description is at the genomic level. Number 1 is the first nucleotide of the genomic reference sequence.
- c. = indicates that the description is at the cDNA level. Number 1 is the A in the translation initiation codon ATG of the cDNA reference sequence.
- p. = indicates that the description is at the protein level. Number 1 is the translation initiation amino acid Methionine of the protein reference sequence.

In Papers I-IV, the nomenclature describing the mutation's consequence in the cDNA and protein sequence has been primarily used. The changed nucleotides are indicated by the bases: Adenine (A), Cytosine (C), Guanine (G) and Thymine (T). Below are examples on mutations identified in this thesis and the interpretation of the mutation's name:

- c.543+59A>G: The nucleotide change is in the noncoding region of the gene. The closest coding nucleotide relative to the nucleotide substitution is number

543 which, in this case is the last nucleotide of an exon, and the 59<sup>th</sup> nucleotide into the noncoding sequence is a transition from an A to G.

- c.1069G>C → p.Arg361Thr: at nucleotide number 1069 in the coding sequence the wild type G has been changed to C. This genetic change results in a change in the protein sequence at amino acid number 361 where the wild type amino acid Arginine (Arg) has been changed to Threonine (Thr).
- c.102delC → p.Gly35GlufsX10: The nucleotide number 102, which is a C, in the coding sequence has been deleted. This change in the coding sequence result in a frame shift (fs) and the amino acid at position 35 changes from Glycine (Gly) to Glutamic acid (Glu). The frame shift leads to a stop codon (X) at the 10<sup>th</sup> codon from the initial amino acid change.

## BIOINFORMATICS

A method to determine the consequence of a genetic variation is to perform *in silico* analysis. In Papers III and IV, splice site prediction programs and programs predicting the degree of pathogenicity of an amino acid substitution were used. There are different algorithms for predicting the consequence of a genetic variation and that is why it is important to use different programs, especially for splice site prediction. Variations located in the intronic sequence can either have no deleterious effect or an impact on e.g. splicing by creating a new splice donor site. For missense variations, prediction programs use information for instance about the evolutionary conservation and the differences in physicochemical properties between the substituted amino acids to determine the degree of pathogenicity.

## FUNCTIONAL ANALYSIS

### Real-time PCR

In Paper I, RT-PCR was used to assess the relative reduction of mutation carrier's *GRN* mRNA levels compared to non-carriers. An important aspect when running RT-PCR is the selection of internal standards. It is important to choose an internal control that is stable in different individuals, not dependent on cell type and has a similar expression level as the target. The choice is vital to be able to interpret the results as an effect of the mutation and not the effect of the internal control. In order to overcome these problem two internal controls were chosen:  $\beta$ -actin which is a widely used internal control, and the ribosomal protein, large, P0 (*RPLP0*) which expression was shown to be stable in fibroblasts using gene expression data from Nagasaka et al. 2005<sup>124</sup>.

### GRN ELISA

To evaluate what the consequence of a potentially pathogenic mutation has on the protein is important because even if you see an effect in the mRNA it might not be reflected in the protein or vice versa. For example, the *GRN* mutation p.Ala9Asp did not result in any changes in *GRN* mRNA expression levels instead it was shown to impair GRN protein secretion since the mutation is located in the signaling peptide. Measuring the GRN concentration in plasma demonstrated ~50 % reduction in secreted GRN protein<sup>53, 79, 125</sup>. The majority of *GRN* mutations result in haploinsufficiency of functional GRN protein. In Paper III, the GRN protein concentration in serum was

measured using Progranulin human ELISA kit (Adipogen, Incheon, Korea) which has pre-coated wells with polyclonal antibodies.

## ETHICAL CONSIDERATIONS

For all studies local ethical permissions were obtained:

- dnr 485/02: Sample collection
- dnr 484/02: Genetic research – Alzheimer disease
- dnr 2007/661-32 (addendum to dnr 484/02): Biochemical research
- dnr 2007/1212-32 (addendum to dnr 484/02 and dnr 2007/661-32): Genetic research – other diagnoses including frontotemporal dementia
- dnr 01-114: Data collection and genetic analyses on individuals from Swedish National study on Aging and Care
- dnr 03-398: Genetic and biochemical research on ALS/MND/dementia

Informed consent has been obtained for all the patients included in the studies.

The thesis contains several ethical considerations since it includes genetic studies and studies on individuals who have developed dementia. The identities of the patients included in the studies are anonymous in order to protect the families. Another important reason is that a mutation screen performed for research purpose can be treated as a genetic test if the identity of the patient is revealed. The results from a genetic screen done in a research setting are not communicated directly to the participants. One reason is that there are individuals that are willing to participate in genetic research but do not want to know the results. However, there are families that have expressed their desire to have the information and in those cases the results can be communicated to the families in a clinical genetics setting which can offer genetic counseling. The question about genetic testing is complex especially since there are no cures for FTD and ALS. The ethical aspect concerning clinical genetic testing are several and important to keep in mind but will not be discussed further here more than that our research work is performed in close collaboration with the Genetics Unit at the Department of Geriatric medicine in the Karolinska University Hospital ensuring professional genetic counseling when requested.

In Papers II and III possible modifying genes have been investigated. However, to use such information in a clinical setting is still too early since the roles of the modifiers have not been absolutely proven and more research is needed. Furthermore, most importantly, to carry a risk allele does not automatically mean that you will develop the disease and absence of a risk allele does not exclude the risk to develop the disease.

Another important ethical question is that the subjects included in this thesis are patients with dementia and can therefore not themselves give informed consent which is instead obtained from a relative. In addition, it can be difficult to determine when a person is cognitively healthy enough to be able to give informed consent. However, in order to perform research on dementia we need to have samples from patients with dementia.

To perform genetic studies you need DNA which is most commonly obtained from a blood sample where the invasiveness is relatively low. However, to study e.g. the

consequence of a mutation on the RNA or protein level, you may need samples from a more invasive source such as a skin biopsy. Furthermore, to perform studies using post-mortem brain tissue is invasive and even the question about brain donation can be considered invasive. Thus, it can be ethically questionable if it is right to take invasive samples from a patient with dementia when it is his/her relative that has given the informed consent. However, in order to give a definite diagnosis neuropathological examination is needed. The examination is also important since it can also give valuable information about pathogenic processes e.g. the identity of the aggregated protein, i.e. TDP-43, in the neurons of FTD (including *GRN* mutation carriers) and ALS patients was first discovered in 2006. Soon after this finding, mutations in the *TARDBP* gene were detected and the protein functions are being intensely studied in order to gain knowledge about possible disease mechanism pathways.

Research on FTD and ALS patients is conducted because the disease mechanisms are not known. Furthermore, there is a need for reliable predictive and diagnostic biomarkers and most importantly, a cure for these diseases. Therefore, it can be ethically justified to perform studies using samples from patients with dementia especially since they no longer can actively take part in the fight against their own disease.

## RESULTS AND DISCUSSIONS

Detailed descriptions of the results and discussions are found in Papers I-IV. Summaries of the studies are given here.

### STUDY I

#### Progranulin mutation causes frontotemporal dementia in the Swedish Karolinska Family.

The Swedish Karolinska family has an autosomal dominant inheritance pattern of FTD with a mean age at onset of 53.3 years<sup>126</sup>. Linkage analysis showed linkage to chromosome 17q21 where the *MAPT* gene is located. However, sequencing *MAPT* did not reveal any mutation<sup>127</sup> and immunohistochemical examination of family members did not show tau pathology<sup>126</sup>. When it was discovered that mutations in *GRN*, a gene only ~1.6 Mbp upstream of *MAPT*, could cause FTD we decided to investigate *GRN*.

Sequencing of the *GRN* gene resulted in the detection of a previously reported cytosine (C) deletion in exon 2, c.102delC, which leads to a frame shift and a premature stop codon, p.Gly35GlufsX19 (Figure 5). Segregation analysis of c.102delC showed that the variation was present in all affected individuals and absent in four healthy family members above the age of 70 years. However, the variation was present in six healthy family members, of whom four were below the mean age at onset for this family and two individuals were above the mean age at onset. This indicates that the c.102delC has reduced penetrance (Figure 6).

To investigate the functional consequence of the frame shift variation, total fibroblast RNA was isolated from two individuals from the Karolinska family, one mutation carrier and one non-carrier, and five healthy control individuals who were gender and cell passage matched. The relative level of *GRN* RNA was measured with RT-PCR and showed that there was an ~50 % reduction of *GRN* mRNA in the mutation carrier compared to the non-carriers. When sequencing the cDNA of the mutation carrier, only

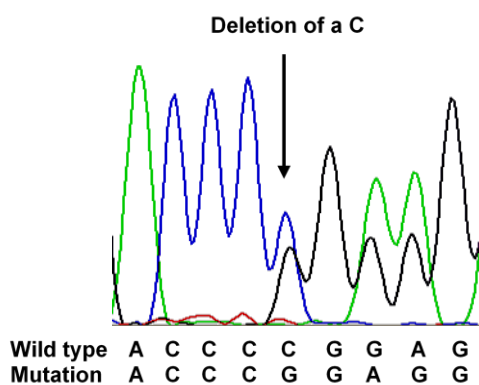

**Figure 5.** Electropherogram of the DNA sequence on the *GRN* mutation c.102delC (arrow). The wild type sequence is on the first row and the sequence with the mutation is below.

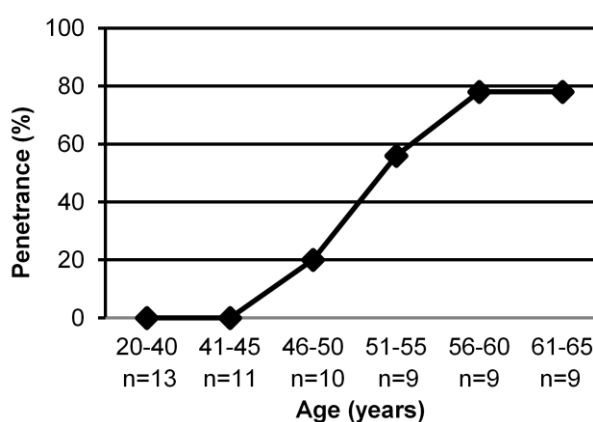

**Figure 6.** Cumulative penetrance curve for c.102delC mutation carriers in the Karolinska family. n = number of mutation carriers that have reached the age group.

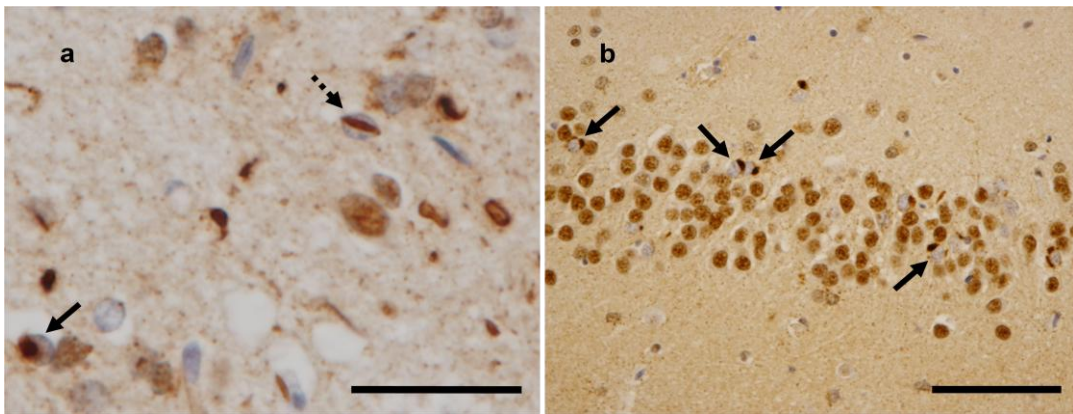
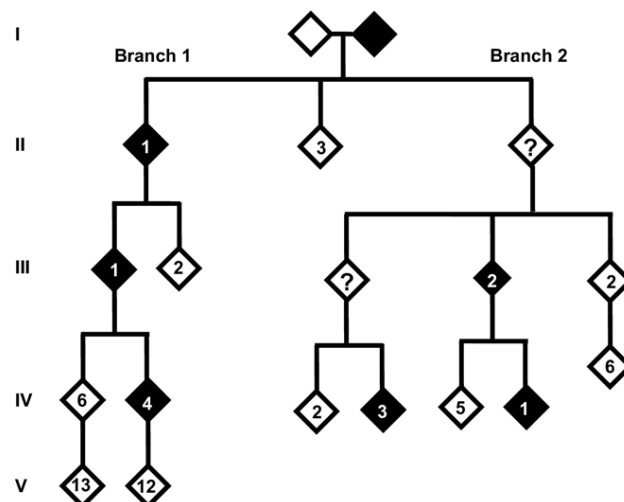

**Figure 7.** Immunohistochemical staining with TDP-43 antibody in (a) the frontal cortex and (b) the granular cells of the dentate gyrus in hippocampus. TDP-43-positive neuronal intranuclear inclusions are indicated with broken arrows and TDP-43-positive neuronal cytoplasmic inclusions are indicated with arrows. Scale bar, 50  $\mu$ m.

the RNA strand without the c.102delC was observed, suggesting that the mutant mRNA has been degraded by nonsense mediated decay and thus resulting in an ~50 % reduction of *GRN* mRNA levels.

Immunohistochemical investigation of two family members with FTD showed that they had neurites, neuronal cytoplasmic and intranuclear inclusions positive for TDP-43 which are characteristic features of *GRN* mutation carriers, FTLTDP type 3 or type A according to new classification (Figure 7) <sup>14</sup>. With these findings the c.102delC was concluded to be pathogenic and causing the disease in the Karolinska family.

Six affected individuals in the Karolinska family have previously been clinically described (branch 1, Figure 8). Here six additional affected individuals in two generations were described (branch 2). The mean age onset for branch 2 was 54.8 years (range 50-58 years) and the duration was 8.2 years (range 4-13 years). In all patients the first sign of disease was psychiatric symptoms such as changes in personality and/or depression. As the disease progressed, all patients developed memory dysfunctions, loss of spontaneous speech and apraxia. Later in the disease, three of the patients developed gait disturbances and two of these cases also had dysphagia. Speech disturbances leading to progressive aphasia were present in both branches of the family.



**Figure 8.** Anonymized pedigree of the Karolinska family with branches 1 and 2. The filled diamonds are individuals diagnosed with FTD, and the clear diamonds are healthy individuals. The number inside the diamonds reflects the number of siblings. The ? represents unclear phenotype.

## STUDY II

### Association of *TMEM106B* gene polymorphism with age at onset in granulin mutation carriers and plasma granulin protein levels.

It is recognized that FTD is a heterogeneous disease with several clinical and neuropathological subgroups and is therefore suspected to have diverse genetic components. In an FTD-GWAS study consisting only of FTLD-TDP patients, an association between three SNPs, in LD, and age at onset was found. The SNP with the strongest significance was rs1990622 which was located ~6.9 kbp downstream and in LD with the gene *TMEM106B*. Furthermore, the association with age at onset was strongest among the *GRN* mutation carriers<sup>85</sup>. In order to determine if rs1990622 can modify age at onset in *GRN* mutation carriers the SNP was genotyped in 50 mutation carriers (affected n = 27 and unaffected n = 23) from four families (Table 1).

The correlation between age at onset and rs1990622 genotype was assessed using the Kaplan-Meier method and tested for significant differences using a Cox proportional hazards model (Figure 9). The analysis showed that patients homozygous for the risk allele A had a median age at onset 13 years earlier compared to patients who were heterozygous or homozygous for the minor allele G ( $p = 9.9 \times 10^{-7}$ ).

To investigate possible disease mechanisms for rs1990622 in FTLD-TDP, the levels of plasma-GRN were measured in 73 healthy individuals and six *GRN* mutation carriers. The association between plasma-GRN levels and rs1990622 genotype was studied by using analysis of covariance. In healthy individuals the plasma-GRN levels were higher and more variable ( $163 \pm 61$  ng/ml; range 76-314 ng/ml) compared to *GRN* mutation carriers ( $47 \pm 13$  ng/ml; range 42-70 ng/ml). A significant difference in mean plasma-GRN levels was observed in the healthy elderly individuals where individuals homozygous for the A allele had the lowest plasma-GRN levels while heterozygous had intermediate plasma-GRN levels and individuals homozygous for the G allele had the highest GRN levels ( $p = 4 \times 10^{-4}$ ) (Table 2). In *GRN* mutation carriers a similar

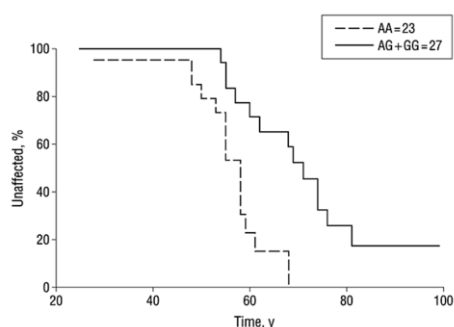

**Figure 9.** Age at onset was analyzed for association with rs1990622 in 50 *GRN* mutation carriers by the Kaplan-Meier method and tested for significant differences using a Cox proportional hazards model. Patients homozygous for the major allele A had an earlier age at onset than the patients heterozygous and homozygous for the minor allele G ( $p = 9.9 \times 10^{-7}$ ).

**Table 1. Sample Description**

Family	Mutation	Sample Size	No. Affected	No. Unaffected	AAO, y, Mean (SD)	Age at Last Assessment, y, Mean (SD)
HDDD1	Ala237fs	6	3	3	62.0 (2)	66.3 (17)
FD1	Ala237fs	13	3	10	59.0 (7)	50.4 (10)
HDDD2	Ala9Asp	18	14	4	61.6 (18)	65.6 (9.3)
Karolinska	Gly35fs	13	7	6	53.5 (4)	41.8 (13)
<b>Total</b>		<b>50</b>	<b>27</b>	<b>23</b>		

Abbreviation: AAO, age at onset.



**Table 2. Rs1990622 Is Associated With GRN Plasma Levels<sup>a</sup>**

rs1990622	Sample Size	GRN Plasma Levels, ng/ml Mean (SD) [Range]
AA	25	156.96 (55.17) [76.50-278.10]
AG	37	170.39 (51.30) [91.90-300.20]
GG	11	209.25 (59.96) [116.70-314.10]

Abbreviation: GRN, granulin.

<sup>a</sup>P value for the additive model:  $P=4 \times 10^{-4}$ .

significant effect was observed (AA genotype:  $49 \pm 10$  ng/ml, range 40-66 ng/ml vs. AG genotype:  $63 \pm 10$  ng/ml, range 56-71 ng/ml;  $p = 0.003$ ).

In the reported FTD-GWAS, rs1990622 was also shown to be associated with *TMEM106B* gene expression in lymphoblastoid cell lines and in frontal cortex from seven neurologically healthy individuals and 18 patients with FTLT-DTP suggesting that rs1990622 modifies the risk for FTLT-DTP through modulation of *TMEM106B* mRNA expression. However, this could not be replicated in our study where cDNA from frontal cortex of 40 individuals without clinical dementia were analyzed. It could be that in the FTD-GWAS the majority of analyzed RNA was isolated from FTLT-DTP patients and in this study only healthy individuals were analyzed. Thus, in the FTD-GWAS the effect of rs1990622 on *TMEM106B* mRNA expression level was primarily found in FTLT-DTP. Furthermore, we investigated if rs1990622 had an effect on the *GRN* expression levels but no correlation was observed. This indicates that the association between rs1990622 and plasma-GRN levels was not caused by modifying the *GRN* mRNA expression levels.

In summary, an association between age at onset for *GRN* mutation carriers and homozygous A allele carriers was observed. Furthermore, the genotype of rs1990622 was shown to modulate the plasma-GRN levels in *GRN* mutation carriers and healthy non-carriers, with AA genotypes having significantly lower plasma-GRN levels compared to the other genotypes. However, the disease mechanism for this association is unclear since the modulatory effect was not explained by the levels of *TMEM106B* mRNA or *GRN* mRNA.

### STUDY III

#### Novel progranulin mutations with reduced serum-progranulin levels in frontotemporal dementia.

It has been reported that up to 50 % of all FTD patients have a positive family history of dementia. In order to investigate the importance of *GRN* mutations in our FTD cohort 100 patients with different FTD sub-diagnoses such as SD, PNFA, FTD-ALS and dementia with frontal signs were sequenced. The sequencing resulted in the detection of two missense variations (p.Arg432Cys and p.Arg433Trp) and four premature stop codon variations: two frame shift (p.Gly35GlufsX19 and p.Cys416LeufsX30) and two nonsense (p.Tyr294X and p.Cys404X). Of the detected

**Table 3.** Patients with potentially pathogenic variations in *GRN*.

Patient ID	Protein <sup>a</sup>	rs5848 genotype	rs1990622 genotype	Serum GRN concentration (ng/ml)	Age at onset (years)	Age at death (years)	Clinical subgroup	Family history <sup>b</sup>	Neuropathological diagnosis
A01	p.Arg432Cys	C/T	A/A	117.7	58	69	FTD or AD with parkinsonism	No information	
B01	p.Gly35GlufsX19	C/T	A/A	31.1	before 59	alive <sup>c</sup>	PPA	Yes	
C01	p.Cys416LeufsX30	C/T	A/G	46.7 <sup>d</sup>	64	71	AD	Yes	FTLD-TDP
D01	p.Tyr294X	C/T	A/A	42.2	54	58	PNFA	Yes	FTLD-TDP
E01	p.Tyr294X	C/T	A/A	44.0	69-70	76	bvFTD	Yes	
F01	p.Cys404X	C/T	A/G		58	66	bvFTD	No information	

FTD frontotemporal dementia; AD Alzheimer disease; PPA primary progressive aphasia; PNFA progressive non-fluent aphasia; bvFTD behavior variant FTD

<sup>a</sup> The numbering is according to NP\_002078.1 with methionine as amino acid 1.

<sup>b</sup> Positive family history is defined as having dementia in at least one first degree relative or at least one second degree relative (including half siblings).

<sup>c</sup> The information is current as of February 2012.

<sup>d</sup> GRN concentration obtained from a family member with the same mutation.

variations only the p.Arg433Trp was identified in one out of 171 neurologically healthy individuals.

The p.Gly35GlufsX19 (p.Gly35fs) was detected in a patient diagnosed with primary progressive aphasia with an age at onset before 59 years (Table 3). This variation has previously been reported in the Karolinska family and haplotype analysis showed that these two families shared a disease haplotype of at least 297 bp. The result indicates that these two families are either very distantly related or that the p.Gly35fs mutation has arisen twice, i.e. either the disease haplotype is identical by descent or state.

The p.Cys416LeufsX30 (p.Cys416fs) was detected in a patient who first was diagnosed with AD and later received the neuropathological diagnosis FTLD-TDP with type 3 histology, corresponding to type A with the new classification<sup>14</sup> (Figure 10 a-c). The proband belonged to a family with a positive history for different types of dementia such as AD and vascular dementia. Segregation analysis was performed on additional affected (n = 6) and non-affected (n = 11) family members. All of the affected family members were shown to carry p.Cys416fs except for two patients: one diagnosed with multiple sclerosis and one patient who had suffered from mano-depressive disease from

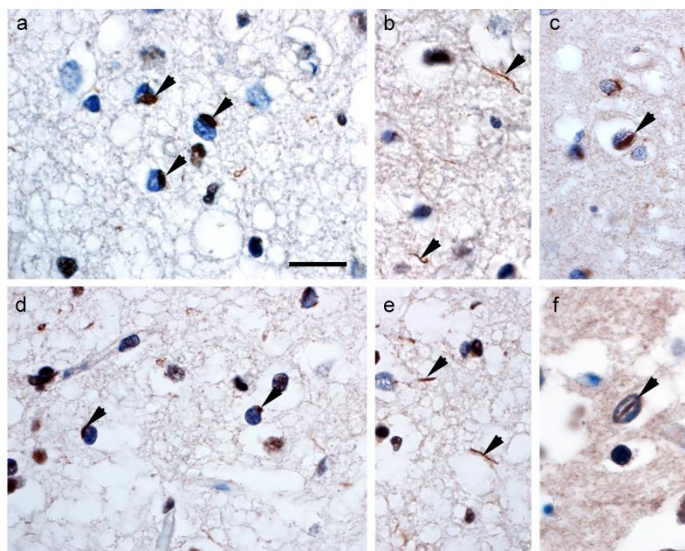

**Figure 10.** Immunohistochemical staining of the frontal cortex with TDP-43 antibody on the patient with the p.Cys416LeufsX30 mutation (figure 10 a-c) and the patient with p.Tyr294X mutation (Figure 10 d-f). TDP-43 immunoreactive neuronal cytoplasmic inclusions (arrows in figure a and d), neurites (arrows in figure b and e) and intranuclear inclusions (arrow in figure c and f) were detected in both patients. Scale bar, 20  $\mu$ m.

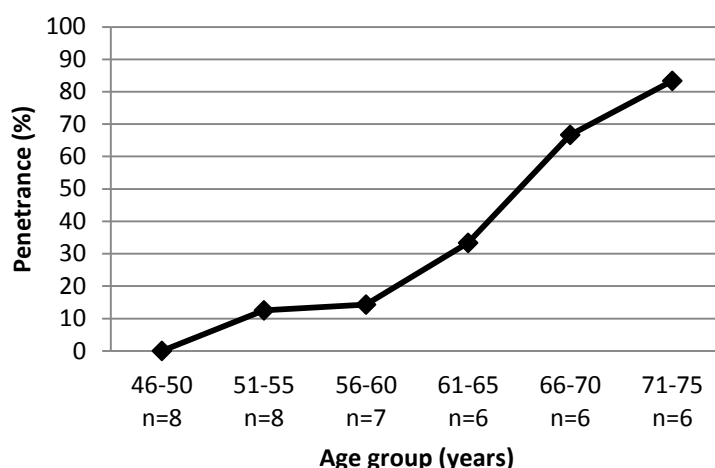
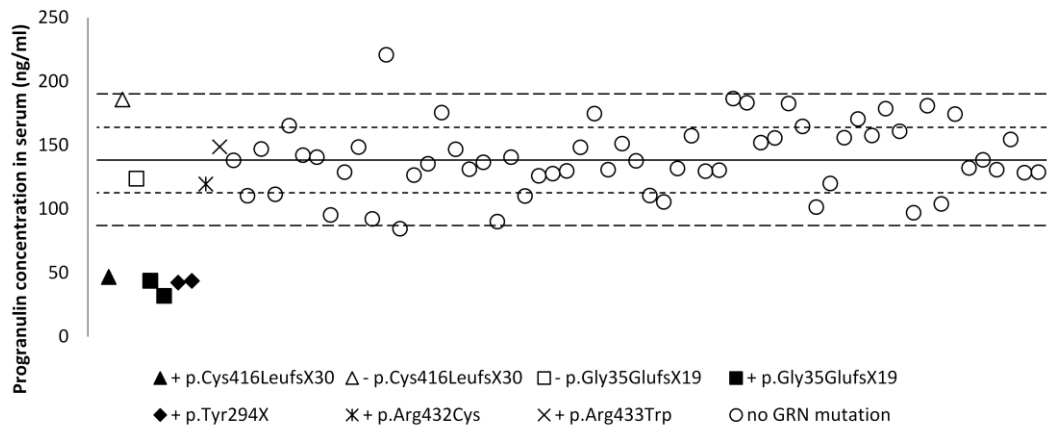

**Figure 11.** Penetrance curve of eight p.Cys416LeufsX30 carriers. The curve shows the percentage of mutations carriers that have developed the disease in an age group. n = number of mutation carriers that have reached the age group.

his 30's and later developed dementia and which was diagnosed as FTD at the age of 81 years. The mean age at onset for the carriers was 65.2 years (range 55-71 years). Of the healthy family members, the p.Cys416fs was absent in eight individuals, of whom three were above the age of 75 years. One of the healthy relatives who carried the frame shift variation was above the mean age at onset indicating that p.Cys416fs has reduced penetrance (Figure 11).

The p.Tyr294X was detected in two FTD patients with different clinical subtypes and a 14 years difference in age at onset (Table 3). It was not possible to perform haplotype analysis on these two patients. However, genotyping seven *GRN* SNPs and the microsatellites flanking *GRN* showed that they shared alleles spanning from D17S1789 to D17S792 which corresponds to an ~16.5 Mbp region. Neuropathological examination of one of the p.Tyr294X carriers resulted in the diagnosis FTLD-TDP with type 3 histology corresponding to type A (Figure 10 d-f) <sup>14</sup>.

It is known that *GRN* mutations have reduced penetrance which indicates the presence of modifying genes and one possible modifying gene is rs1990622 (see Study II). Investigating the SNP in patients carrying *GRN* mutations (n = 9) showed a trend of 10 years earlier age at onset for patients with one or two A alleles compared to GG patients ( $59.6 \pm 8.7$  years and  $69.5 \pm 2.1$  years respectively). However, since there were only nine mutation carriers, no robust statistical analysis could be performed. In contrast, analyzing rs1990622 in the total patient cohort did not reveal any correlation with age at onset. Another possible modifying gene is *APOE* and a significant difference in mean age at onset was detected between *APOE*  $\epsilon$ 4 negative and positive FTD patients ( $58.3 \pm 8.4$  years and  $62.6 \pm 7.2$  years respectively) with a p value of 0.01. This finding is in contrast to previous studies where either an association to an earlier age at onset for  $\epsilon$ 4 positive patients has been reported or no association at all. However, it has previously been reported that *GRN* mutation carriers who were also positive for *APOE*  $\epsilon$ 4 had a later age at onset compared to  $\epsilon$ 4 negative carriers, which is in agreement with our observation <sup>42, 79</sup>.



**Figure 11.** Serum progranulin protein concentrations in 64 FTD patients and additional family members of *GRN* mutation carriers and non-carriers. The “+” indicates mutation carrier and the “-“ indicates family members that do not carry the *GRN* mutation. The black line indicates the mean serum-GRN level, 139.7 ng/ml, of all FTD patients without premature stop codons (n = 61). The dashed line represents one and two standard deviations from the mean value, respectively.

The serum-GRN levels were measured in 64 out of 100 FTD patients (Figure 11). Serum was available for all the detected variations affecting the amino acid sequence except for p.Cys404X. The serum-GRN levels were more than 50 % reduced in the premature stop codon carriers compared to patients that did not carry any premature stop codons, mean concentration of  $41.7 \pm 5.7$  ng/ml (range 31.9-46.7 ng/ml) and  $139.7 \pm 27.5$  ng/ml (range 84.5-220.8 ng/ml) respectively (Figure 11). This suggests that the premature stop codon variations are pathogenic since they result in more than 50 % reduction in serum-GRN. Furthermore, large variations in the serum-GRN levels were observed among FTD patients that did not carry premature stop codons. Possible modifying genes for the detected GRN level differences were investigated: rs5848, rs1990622 and *APOE*. Investigating these SNPs, only the rs5848 reached significance ( $p = 0.04$ ). Patients homozygous for the minor allele T had significantly lower serum-GRN concentration ( $120.0 \pm 23.9$  ng/ml) compared to CC and CT genotypes ( $138.9 \pm 24.5$  ng/ml and  $146.3 \pm 28.1$  ng/ml respectively). This is in agreement with previous reports where it was hypothesized that miR-659 could inhibit *GRN* translation more efficiently when it binds to the rs5848 T allele transcript compared to C allele.

In summary, four *GRN* premature stop codon mutations were detected, where three demonstrated a more than 50 % reduction in serum-GRN levels. The *GRN* mutations also demonstrated clinical heterogeneity in patients with the same mutation. Three possible modifying factors for age at onset and GRN levels were investigated. The *APOE* showed significance for age at onset with  $\epsilon 4$  positive patients having a later age at onset compared to  $\epsilon 4$  negative patients. Furthermore, the genotype of rs5848 was associated with the serum-GRN levels with TT genotype having significantly lower levels compared to the other genotypes.

## STUDY IV

### Novel *TARDBP* mutations in Nordic ALS patients.

In 2006 it was shown that the majority of ALS patients had TDP-43 immunoreactive neuronal inclusions. Thus, it was hypothesized that mutations in the *TARDBP* gene

**Table 4.** Summary of the clinical description of patients carrying missense variations in *TARDBP*.

Patient ID	Protein position <sup>a</sup>	Family history	Nationality	Diagnosis	Age at onset (years)	First symptom	Survival (years)
1:A	p.A90V <sup>b</sup> p.G357R <sup>b,c</sup>	Yes	Danish	ALS	67	Dysarthria	2
2:A <sup>d</sup>	p.R361T <sup>c</sup>	Yes	Norwegian	ALS	69	Paresis in left leg	6
2:B <sup>d</sup>	p.R361T <sup>c</sup>	Yes	Norwegian	FTD-ALS	66	Deficits in verbal fluency and memory	2
3:A	p.S379P	Yes	Danish	ALS	62	Weakness in legs and difficulties with walking	3

<sup>a</sup>The numbering is according to the longest amino acid sequence (ENSP00000240185) with Met as amino acid 1.

<sup>b</sup>Both variations identified in the same individual.

<sup>c</sup>Not previously reported.

<sup>d</sup>2:A and 2:B belong to the same family.

could cause ALS. We therefore sequenced the *TARDBP* gene in 177 ALS patients from the Nordic countries and found several non-coding variations and four missense variations: p.Ala90Val, p.Gly357Arg, p.Arg361Thr and p.Ser379Pro (Table 4). None of the non-coding variations were predicted to affect the splicing except for c.543+59A>G. Three out of four splice site prediction programs predicted a new splice donor site in c.543+59A>G which would result in an 18 amino acid longer exon 4 coded protein and end with a premature stop codon thereby excluding exons 5 and 6. However, no source for RNA and protein analysis was available for the functional analysis of c.543+59A>G. The c.543+59A>G was identified in a patient with spinal onset ALS at the age of 68 years. Segregation analysis in additional family members showed that the variation was present in one healthy relative but absent in a relative with ALS. This variation was absent in 200 neurologically healthy individuals. Thus, the pathogenic nature of c.543+59A>G is unclear.

The four missense variations were detected in three FALS patients and absent in 200 neurologically healthy control individuals. The two missense variations p.Ala90Val and p.Gly357Arg were present in the same patient who developed bulbar onset ALS at the age of 67 years (Table 4). Segregation analysis in six healthy family members of whom four were above the age of 70 years, showed that two of the relatives between the ages of 50-70 years carried either of the two missense variations. There was also one family member above the age of 70 years who carried both p.Ala90Val and p.Gly357Arg, and was still healthy. The p.Ala90Val has previously been reported in healthy individuals in a higher frequency than in ALS patients indicating that this variation might be a rare but non-pathogenic variation. However, *in vitro* data indicates that p.Ala90Val might impair the shuttling of TDP-43 between the cytosol and the nucleus since the variation is located in the nucleus localization signal. Thus, it is possible that p.Ala90Val has a modifying effect on TDP-43 as a risk factor but cannot alone cause ALS. The other missense variation found in the patient, p.Gly357Arg, was predicted to be pathogenic by bioinformatics. Thus, it is possible that p.Gly357Arg caused the disease in the family, and p.Ala90Val acts as a modifying risk factor.

The p.Arg361Thr was detected in a patient who developed spinal onset ALS at the age of 69 years (Table 4). Segregation analysis demonstrated that the variation segregated

with the disease. In addition, there was a relative who developed FTD at the age of 66 years and as the disease progressed, also developed ALS. Thus, p.Arg361Thr is likely pathogenic and can cause both ALS and FTD-ALS.

The fourth and last missense variation, p.Ser379Pro, was detected in an ALS patient with spinal onset at the age of 62 years (Table 4). Segregation analysis could not be performed and the variation was not detected in the healthy control cohort. This variation has previously been reported to be pathogenic which was also our conclusion.

Taken together, the mutation frequency of *TARDBP* in our ALS cohort was 1.7 % which is low compared to other reports (FALS ~5 %) and considering that the cohort was selected with the preference of patients with a positive family history, indicates that mutations in *TARDBP* are a rare cause for ALS in the Nordic countries.

## CONCLUDING REMARKS AND FUTURE PERSPECTIVES

In this thesis, genetic analyses have been performed on FTD and ALS patients. The genetics of FTD has been investigated with respect to *GRN* mutation frequency and possible modifying genes. In **Paper I**, the mutation responsible for the disease in a family with dominantly inherited FTD showing linkage to chromosome 17 was finally identified in the *GRN* gene. The varied age at onset in this and other *GRN* mutation families raised the question about possible modifying genes. Possible modifying SNPs in LD with the gene *TMEM106B* were discovered in the first published FTD-GWAS. In **Paper II** the top SNP, rs1990622, was investigated in four families with *GRN* mutations. It was shown that patients homozygous for the risk allele had a significantly lower age at onset compared to the other genotypes. Additional investigation on possible functional effects of the SNP was performed and demonstrated that the risk allele could modify the *GRN* protein levels in plasma.

In **Paper III** the mutation frequency of the *GRN* gene and three possible disease modifying factors (rs1990622, rs5848 and *APOE*) were investigated in 100 patients with different FTD subtypes. The mutation screening revealed a 4 % mutation frequency in patients with FTD in Sweden. The initial idea of replicating the association between age at onset and rs1990622 from Paper II was not possible because the numbers of patients carrying *GRN* mutations were too few to perform statistical analysis. However, investigating the three SNPs in the whole FTD patient cohort revealed that patients positive for the *APOE*  $\epsilon$ 4 allele had a significantly later age at onset compared to  $\epsilon$ 4 negative patients. This finding has previously been reported in *GRN* mutation carriers, but the possible protective mechanism of  $\epsilon$ 4 allele is unknown. The three SNPs' effect on serum-*GRN* levels were studied and we could not replicate our finding from Paper II where rs1990622 were shown to modify *GRN* protein levels. However, we did observe that rs5848 could modify the *GRN* levels, where patients homozygous for the T allele had significantly lower serum-*GRN* levels compared to the other genotypes. This finding is in line with previous reports about the rs5848 being a binding site for miR-659 which can influence the *GRN* translation.

It is recognized that FTD and ALS are part of the same disease spectrum. The largest neuropathological FTL D subgroup has TDP-43 positive neuronal inclusions, including *GRN* mutation carriers, and the majority of ALS patients also have TDP-43 immunoreactive neuronal inclusions. In **Paper IV**, the mutation frequency of the gene encoding TDP-43, *TARDBP*, was investigated in ALS patients from the Nordic countries. From our mutation screen it was concluded that mutations in *TARDBP* is a rare cause for ALS, representing 1.7 % of the Nordic ALS patients in our cohort. Furthermore, one of the detected mutations was present in a family with both ALS and FTD-ALS which further strengthens the connection between the two diseases.

The findings from Study I-IV show that there are still unidentified genetic factors that can contribute or cause FTD and/or ALS. A recent finding in 2011, was the identification of *C9orf72* mutations in high frequency in patients with FTD, FTD-ALS and ALS and has therefore prompted us and other groups to investigate the gene in

respective patient cohorts. We have in collaboration with international groups included 73 patients from Sweden (FTD n = 64; FTD-ALS n = 7; ALS n = 2) for *C9orf72* mutation screening. The preliminary results indicate that 19 of the 73 patients carry the hexanucleotide expansion (FTD n = 14; FTD-ALS n = 4; ALS n = 1), which corresponds to a mutation frequency of 26 %. This preliminary data suggests that mutations in *C9orf72* are the most common known cause of FTD and FTD-ALS patients in Sweden.

Even with the identification of mutation in *C9orf72* there are still other unknown genes with pathogenic mutations and modifying effects on disease course (age at onset and survival) and clinical phenotype. New FTD-GWAS is ongoing and it will be interesting to see what the results will be. Furthermore, the rapid use of new methods such as next generation sequencing, which makes it possible to sequence the whole genome and exome, opens up new opportunities to find disease causing mutations in unknown genes, and challenges in handling and interpreting all the generated information.

There are still no cures for FTD or ALS. However, for patients with *GRN* mutations there are investigation for proteins that can increase the GRN levels. The proteins that are currently used clinically for other diseases have been shown *in vitro* to elevate the GRN protein levels by up-regulating the transcription or the translation of *GRN*<sup>128, 129</sup>. It is still too early to predict the outcome of these drugs since they have not been tested *in vivo*. If there is an effective and safe drug that can elevate the GRN levels to the normal, genetic testing can be used to target the patients with *GRN* mutations and give the drug before the neurodegeneration occurs.



## ACKNOWLEDGEMENTS

There are many people that I would like to acknowledge for their encouragements and support during my time as a PhD student.

First of all I would like to thank **Caroline Graff**, my main-supervisor, for giving me the opportunity to work with her and her group. Thank you for all your support. You have always encouraged me when I wanted to try new methods. Your enthusiasm and dedication for science and patients is an inspiration for me. If I have half of your energy I know I will do well in the future.

**Peter M. Andersen**, my co-supervisor, thank you for introducing me to the world of ALS. You are one of the few people who can rival with Caroline in energy and enthusiasm for science.

**Bengt Winblad**, thank you for creating a great research atmosphere and for all you hard work on improving our section KI-Alzheimer Disease Research Center.

A big thank you to all the past and present members of **Translational genetic team** for all the support and fun talks, in and out of the lab: Anna Sandebring, Anna Sillén, Anne Kinhult-Ståhlbom, Annica Rönnbäck, Behnosh Fakhir Björk, Håkan Thonberg, Inga Volkmann, Jenny Björkström, Jesper Brohede, Karin Axelman, Lena Lilius, Lina Keller, Lotta Forsell, Marie Fallström, Mette Bergman, Mimi Olofsson Westerlund, Steinunn Thordardottir and Tiina Robins.

**Lina Keller**, for all the help in the jungle of being a PhD student and all the nice “frukt stund”. It was great fun to share the office with you.

**Lena Lilius**, for all the fun talks, it brightened up my days. And, of course, for all the help with the serious scientific questions.

**Lotta Forsell**, for always having the time and patients to help me when I came running. And it was great to find out that we have the same taste in movies.

**Håkan Thonberg**, for all the nice methodological discussions. And for all your talks about cooking. It almost made me want to put more effort in learning how to cook.

**All the collaborators**, thank you for your contributions to the Papers I-IV. Especially Inger Nennesmo, Linn Öijerstedt and Shan Krishnan for always being kind and supportive.

**All the past and present people at NVS and KASPAC**, thank you for making my time here fun and enjoyable. Especially Alina Codita, Annelie Svensson, Hedvig Welander, Heela Sarlius, Jenny Frånberg, Ji-Yeun Hur, Johanna Wanngren and Louise Hedskog for being great colleagues and to the participants in **Kandel-book club** for sharing the joy and suffering.

**Gunilla Johansson, Anna Gustavsson, Anna Jorsell, Balbir Dhuper and Eva Holmgaard**, for the support with all the administrative work.

Finally **my Family**, there are many things that I would like to say but I cannot find the words. So, I will just say: thank you for being there for me, for showering me with love and support. I am glad that you remind me that there is a world outside the lab and that it is not the end of the world if I have not finished sequencing all the samples before the weekend.

\*\*\*\*\*

I would like to acknowledge the people participating and contributing to research.

This thesis was supported by: Karolinska Institutet doctoral student funding, Swedish Brain Power, Gun and Bertil Stohne's foundation, Gamla tjänarinnors foundation and Demensförbundet.

## REFERENCES

1. Neary D, Snowden JS, Gustafson L et al. Frontotemporal lobar degeneration: a consensus on clinical diagnostic criteria. *Neurology*. 51, 1546-1554 (1998)
2. Seelaar H, Kamphorst W, Rosso SM et al. Distinct genetic forms of frontotemporal dementia. *Neurology*. 71, 1220-1226 (2008)
3. Lomen-Hoerth C, Anderson T, Miller B. The overlap of amyotrophic lateral sclerosis and frontotemporal dementia. *Neurology*. 59, 1077-1079 (2002)
4. McKhann GM, Albert MS, Grossman M et al. Clinical and pathological diagnosis of frontotemporal dementia: report of the Work Group on Frontotemporal Dementia and Pick's Disease. *Arch Neurol*. 58, 1803-1809 (2001)
5. Seelaar H, Rohrer JD, Pijnenburg YA et al. Clinical, genetic and pathological heterogeneity of frontotemporal dementia: a review. *J Neurol Neurosurg Psychiatry*. 82, 476-486 (2011)
6. Seilhean D, Le Ber I, Sarazin M et al. Fronto-temporal lobar degeneration: neuropathology in 60 cases. *J Neural Transm*. 118, 753-764 (2011)
7. van Langenhove T, van der Zee J, van Broeckhoven C. The molecular basis of the frontotemporal lobar degeneration-amyotrophic lateral sclerosis spectrum. *Ann Med*. (2012)
8. Lillo P, Hodges JR. Frontotemporal dementia and motor neurone disease: overlapping clinic-pathological disorders. *J Clin Neurosci*. 16, 1131-1135 (2009)
9. Cairns NJ, Bigio EH, Mackenzie IR et al. Neuropathologic diagnostic and nosologic criteria for frontotemporal lobar degeneration: consensus of the Consortium for Frontotemporal Lobar Degeneration. *Acta Neuropathol*. 114, 5-22 (2007)
10. Mackenzie IR, Neumann M, Bigio EH et al. Nomenclature for neuropathologic subtypes of frontotemporal lobar degeneration: consensus recommendations. *Acta Neuropathol*. 117, 15-18 (2009)
11. Mackenzie IR, Neumann M, Bigio EH et al. Nomenclature and nosology for neuropathologic subtypes of frontotemporal lobar degeneration: an update. *Acta Neuropathol*. 119, 1-4 (2010)
12. Neumann M, Roeber S, Kretschmar HA et al. Abundant FUS-immunoreactive pathology in neuronal intermediate filament inclusion disease. *Acta Neuropathol*. 118, 605-616 (2009)
13. Seelaar H, Klijnsma KY, de Koning I et al. Frequency of ubiquitin and FUS-positive, TDP-43-negative frontotemporal lobar degeneration. *J Neurol*. 257, 747-753 (2009)
14. Mackenzie IR, Neumann M, Baborie A et al. A harmonized classification system for FTLTD-TDP pathology. *Acta Neuropathol*. 122, 111-113 (2011)
15. Neumann M, Rademakers R, Roeber S et al. A new subtype of frontotemporal lobar degeneration with FUS pathology. *Brain*. 132, 2922-2931 (2009)
16. Arai T, Hasegawa M, Akiyama H et al. TDP-43 is a component of ubiquitin-positive tau-negative inclusions in frontotemporal lobar degeneration and amyotrophic lateral sclerosis. *Biochem Biophys Res Commun*. 351, 602-611 (2006)
17. Neumann M, Sampathu DM, Kwong LK et al. Ubiquitinated TDP-43 in frontotemporal lobar degeneration and amyotrophic lateral sclerosis. *Science*. 314, 130-133 (2006)
18. Rademakers R, Hutton M. The genetics of frontotemporal lobar degeneration. *Curr Neurol Neurosci Rep*. 7, 434-442 (2007)
19. Rohrer JD, Guerreiro R, Vandrovicova J et al. The heritability and genetics of frontotemporal lobar degeneration. *Neurology*. 73, 1451-1456 (2009)

20. Baker M, Mackenzie IR, Pickering-Brown SM et al. Mutations in progranulin cause tau-negative frontotemporal dementia linked to chromosome 17. *Nature*. 442, 916-919 (2006)
21. Cruts M, Gijselinck I, van der Zee J et al. Null mutations in progranulin cause ubiquitin-positive frontotemporal dementia linked to chromosome 17q21. *Nature*. 442, 920-924 (2006)
22. DeJesus-Hernandez M, Mackenzie IR, Boeve BF et al. Expanded GGGGCC Hexanucleotide Repeat in Noncoding Region of C9ORF72 Causes Chromosome 9p-Linked FTD and ALS. *Neuron*. 72, 245-256 (2011)
23. Gitcho MA, Baloh RH, Chakraverty S et al. TDP-43 A315T mutation in familial motor neuron disease. *Ann Neurol*. 63, 535-538 (2008)
24. Renton AE, Majounie E, Waite A et al. A Hexanucleotide Repeat Expansion in C9ORF72 Is the Cause of Chromosome 9p21-Linked ALS-FTD. *Neuron*. 72, 257-268 (2011)
25. Yokoseki A, Shiga A, Tan CF et al. TDP-43 mutation in familial amyotrophic lateral sclerosis. *Ann Neurol*. 63, 538-542 (2008)
26. Kwiatkowski TJ, Jr., Bosco DA, Leclerc AL et al. Mutations in the FUS/TLS gene on chromosome 16 cause familial amyotrophic lateral sclerosis. *Science*. 323, 1205-1208 (2009)
27. Vance C, Rogelj B, Hortobagyi T et al. Mutations in FUS, an RNA processing protein, cause familial amyotrophic lateral sclerosis type 6. *Science*. 323, 1208-1211 (2009)
28. Benajiba L, Le Ber I, Camuzat A et al. TARDBP mutations in motoneuron disease with frontotemporal lobar degeneration. *Ann Neurol*. 65, 470-473 (2009)
29. Borroni B, Archetti S, Del Bo R et al. TARDBP mutations in frontotemporal lobar degeneration: frequency, clinical features, and disease course. *Rejuvenation Res*. 13, 509-517 (2010)
30. Borroni B, Bonvicini C, Alberici A et al. Mutation within TARDBP leads to frontotemporal dementia without motor neuron disease. *Hum Mutat*. 30, E974-983 (2009)
31. Chiang HH, Andersen PM, Tysnes OB et al. Novel TARDBP mutations in Nordic ALS patients. *J Hum Genet*. (2012)
32. Skibinski G, Parkinson NJ, Brown JM et al. Mutations in the endosomal ESCRTIII-complex subunit CHMP2B in frontotemporal dementia. *Nat Genet*. 37, 806-808 (2005)
33. Watts GD, Wymer J, Kovach MJ et al. Inclusion body myopathy associated with Paget disease of bone and frontotemporal dementia is caused by mutant valosin-containing protein. *Nat Genet*. 36, 377-381 (2004)
34. Broustal O, Camuzat A, Guillot-Noel L et al. FUS mutations in frontotemporal lobar degeneration with amyotrophic lateral sclerosis. *J Alzheimers Dis*. 22, 765-769 (2010)
35. Van Langenhove T, van der Zee J, Sleegers K et al. Genetic contribution of FUS to frontotemporal lobar degeneration. *Neurology*. 74, 366-371 (2010)
36. Hutton M, Lendon CL, Rizzu P et al. Association of missense and 5'-splice-site mutations in tau with the inherited dementia FTDP-17. *Nature*. 393, 702-705 (1998)
37. Goedert M, Spillantini MG, Potier MC et al. Cloning and sequencing of the cDNA encoding an isoform of microtubule-associated protein tau containing four tandem repeats: differential expression of tau protein mRNAs in human brain. *EMBO J*. 8, 393-399 (1989)
38. Rademakers R, Cruts M, van Broeckhoven C. The role of tau (MAPT) in frontotemporal dementia and related tauopathies. *Hum Mutat*. 24, 277-295 (2004)
39. Weingarten MD, Lockwood AH, Hwo SY, Kirschner MW. A protein factor essential for microtubule assembly. *Proc Natl Acad Sci U S A*. 72, 1858-1862 (1975)

40. Hong M, Zhukareva V, Vogelsberg-Ragaglia V et al. Mutation-specific functional impairments in distinct tau isoforms of hereditary FTDP-17. *Science*. 282, 1914-1917 (1998)
41. Spillantini MG, Murrell JR, Goedert M et al. Mutation in the tau gene in familial multiple system tauopathy with presenile dementia. *Proc Natl Acad Sci U S A*. 95, 7737-7741 (1998)
42. Beck J, Rohrer JD, Campbell T et al. A distinct clinical, neuropsychological and radiological phenotype is associated with progranulin gene mutations in a large UK series. *Brain*. 131, 706-720 (2008)
43. Pickering-Brown SM, Rollinson S, Du Plessis D et al. Frequency and clinical characteristics of progranulin mutation carriers in the Manchester frontotemporal lobar degeneration cohort: comparison with patients with MAPT and no known mutations. *Brain*. 131, 721-731 (2008)
44. Rohrer JD, Warren JD. Phenotypic signatures of genetic frontotemporal dementia. *Curr Opin Neurol*. 24, 542-549 (2011)
45. Gijssels I, Van Langenhove T, van der Zee J et al. A C9orf72 promoter repeat expansion in a Flanders-Belgian cohort with disorders of the frontotemporal lobar degeneration-amyotrophic lateral sclerosis spectrum: a gene identification study. *Lancet Neurol*. 11, 54-65 (2011)
46. Majounie E, Renton AE, Mok K et al. Frequency of the C9orf72 hexanucleotide repeat expansion in patients with amyotrophic lateral sclerosis and frontotemporal dementia: a cross-sectional study. *Lancet Neurol*. 11, 323-330 (2012)
47. Hsiung GY, DeJesus-Hernandez M, Feldman HH et al. Clinical and pathological features of familial frontotemporal dementia caused by C9ORF72 mutation on chromosome 9p. *Brain*. 135, 709-722 (2012)
48. Chio A, Borghero G, Restagno G et al. Clinical characteristics of patients with familial amyotrophic lateral sclerosis carrying the pathogenic GGGGCC hexanucleotide repeat expansion of C9ORF72. *Brain*. 135, 784-793 (2012)
49. Chen-Plotkin AS, Martinez-Lage M, Sleiman PM et al. Genetic and clinical features of progranulin-associated frontotemporal lobar degeneration. *Arch Neurol*. 68, 488-497 (2011)
50. Gijssels I, van der Zee J, Engelborghs S et al. Progranulin locus deletion in frontotemporal dementia. *Hum Mutat*. 29, 53-58 (2008)
51. Rovelet-Lecrux A, Deramecourt V, Legallic S et al. Deletion of the progranulin gene in patients with frontotemporal lobar degeneration or Parkinson disease. *Neurobiol Dis*. 31, 41-45 (2008)
52. Cruchaga C, Graff C, Chiang HH et al. Association of TMEM106B gene polymorphism with age at onset in granulin mutation carriers and plasma granulin protein levels. *Arch Neurol*. 68, 581-586 (2011)
53. Finch N, Baker M, Crook R et al. Plasma progranulin levels predict progranulin mutation status in frontotemporal dementia patients and asymptomatic family members. *Brain*. 132, 583-591 (2009)
54. Schofield EC, Halliday GM, Kwok J et al. Low serum progranulin predicts the presence of mutations: a prospective study. *J Alzheimers Dis*. 22, 981-984 (2010)
55. Sleegers K, Brouwers N, Van Damme P et al. Serum biomarker for progranulin-associated frontotemporal lobar degeneration. *Ann Neurol*. 65, 603-609 (2009)
56. Daniel R, He Z, Carmichael KP et al. Cellular localization of gene expression for progranulin. *J Histochem Cytochem*. 48, 999-1009 (2000)
57. Toh H, Chitramuthu BP, Bennett HP, Bateman A. Structure, function, and mechanism of progranulin; the brain and beyond. *J Mol Neurosci*. 45, 538-548 (2011)
58. Zhu J, Nathan C, Jin W et al. Conversion of proepithelin to epithelins: roles of SLPI and elastase in host defense and wound repair. *Cell*. 111, 867-878 (2002)

59. Hu F, Padukkavidana T, Vaegter CB et al. Sortilin-mediated endocytosis determines levels of the frontotemporal dementia protein, progranulin. *Neuron*. 68, 654-667 (2010)
60. Bateman A, Bennett HP. The granulin gene family: from cancer to dementia. *Bioessays*. 31, 1245-1254 (2009)
61. Ahmed Z, Sheng H, Xu YF et al. Accelerated lipofuscinosis and ubiquitination in granulin knockout mice suggest a role for progranulin in successful aging. *Am J Pathol*. 177, 311-324 (2010)
62. Ghoshal N, Dearborn JT, Wozniak DF, Cairns NJ. Core features of frontotemporal dementia recapitulated in progranulin knockout mice. *Neurobiol Dis*. 45, 395-408 (2012)
63. Petkau TL, Neal SJ, Milnerwood A et al. Synaptic dysfunction in progranulin-deficient mice. *Neurobiol Dis*. 45, 711-722 (2012)
64. Yin F, Banerjee R, Thomas B et al. Exaggerated inflammation, impaired host defense, and neuropathology in progranulin-deficient mice. *J Exp Med*. 207, 117-128 (2010)
65. Van Damme P VHA, Lambrechts D, et al. . Progranulin functions as a neurotrophic factor to regulate neurite outgrowth and enhance neuronal survival. *J Cell Biol*. 181, 37-41 (2008)
66. Guo A, Tapia L, Bamji SX et al. Progranulin deficiency leads to enhanced cell vulnerability and TDP-43 translocation in primary neuronal cultures. *Brain Res*. 1366, 1-8 (2010)
67. Kayasuga Y, Chiba S, Suzuki M et al. Alteration of behavioural phenotype in mice by targeted disruption of the progranulin gene. *Behav Brain Res*. 185, 110-118 (2007)
68. Borroni B, Grassi M, Agosti C et al. Establishing short-term prognosis in Frontotemporal Lobar Degeneration spectrum: role of genetic background and clinical phenotype. *Neurobiol Aging*. 31, 270-279 (2010)
69. Strittmatter WJ, Bova Hill C. Molecular biology of apolipoprotein E. *Curr Opin Lipidol*. 13, 119-123 (2002)
70. Strittmatter WJ, Roses AD. Apolipoprotein E and Alzheimer's disease. *Annu Rev Neurosci*. 19, 53-77 (1996)
71. Corder EH, Saunders AM, Strittmatter WJ et al. Gene dose of apolipoprotein E type 4 allele and the risk of Alzheimer's disease in late onset families. *Science*. 261, 921-923 (1993)
72. Bernardi L, Maletta RG, Tomaino C et al. The effects of APOE and tau gene variability on risk of frontotemporal dementia. *Neurobiol Aging*. 27, 702-709 (2006)
73. Farrer LA, Abraham CR, Volicer L et al. Allele epsilon 4 of apolipoprotein E shows a dose effect on age at onset of Pick disease. *Exp Neurol*. 136, 162-170 (1995)
74. Mehta SG, Watts GD, Adamson JL et al. APOE is a potential modifier gene in an autosomal dominant form of frontotemporal dementia (IBMPFD). *Genet Med*. 9, 9-13 (2007)
75. Minthon L, Hesse C, Sjogren M et al. The apolipoprotein E epsilon4 allele frequency is normal in fronto-temporal dementia, but correlates with age at onset of disease. *Neurosci Lett*. 226, 65-67 (1997)
76. Pickering-Brown SM, Owen F, Isaacs A et al. Apolipoprotein E epsilon4 allele has no effect on age at onset or duration of disease in cases of frontotemporal dementia with pick- or microvacuolar-type histology. *Exp Neurol*. 163, 452-456 (2000)
77. Seripa D, Bizzarro A, Panza F et al. The APOE gene locus in frontotemporal dementia and primary progressive aphasia. *Arch Neurol*. 68, 622-628
78. Verpillat P, Camuzat A, Hannequin D et al. Apolipoprotein E gene in frontotemporal dementia: an association study and meta-analysis. *Eur J Hum Genet*. 10, 399-405 (2002)

79. Gass J, Cannon A, Mackenzie IR et al. Mutations in progranulin are a major cause of ubiquitin-positive frontotemporal lobar degeneration. *Hum Mol Genet.* 15, 2988-3001 (2006)
80. Rademakers R, Baker M, Gass J et al. Phenotypic variability associated with progranulin haploinsufficiency in patients with the common 1477C-->T (Arg493X) mutation: an international initiative. *Lancet Neurol.* 6, 857-868 (2007)
81. Rademakers R, Eriksen JL, Baker M et al. Common variation in the miR-659 binding-site of GRN is a major risk factor for TDP43-positive frontotemporal dementia. *Hum Mol Genet.* 17, 3631-3642 (2008)
82. Rollinson S, Rohrer JD, van der Zee J et al. No association of PGRN 3'UTR rs5848 in frontotemporal lobar degeneration. *Neurobiol Aging.* 32, 754-755 (2011)
83. Simon-Sanchez J, Seelaar H, Bochtanovits Z et al. Variation at GRN 3'-UTR rs5848 is not associated with a risk of frontotemporal lobar degeneration in Dutch population. *PLoS One.* 4, e7494 (2009)
84. Hsiung GY, Fok A, Feldman HH et al. rs5848 polymorphism and serum progranulin level. *J Neurol Sci.* 300, 28-32 (2010)
85. Van Deerlin VM, Sleiman PM, Martinez-Lage M et al. Common variants at 7p21 are associated with frontotemporal lobar degeneration with TDP-43 inclusions. *Nat Genet.* 42, 234-239 (2010)
86. Rollinson S, Mead S, Snowden J et al. Frontotemporal lobar degeneration genome wide association study replication confirms a risk locus shared with amyotrophic lateral sclerosis. *Neurobiol Aging.* 32, 758 e751-757 (2011)
87. Finch N, Carrasquillo MM, Baker M et al. TMEM106B regulates progranulin levels and the penetrance of FTL in GRN mutation carriers. *Neurology.* 76, 467-474 (2011)
88. van der Zee J, Van Langenhove T, Kleinberger G et al. TMEM106B is associated with frontotemporal lobar degeneration in a clinically diagnosed patient cohort. *Brain.* 134, 808-815 (2011)
89. Andersen PM, Borasio GD, Dengler R et al. Good practice in the management of amyotrophic lateral sclerosis: clinical guidelines. An evidence-based review with good practice points. EALS Working Group. *Amyotroph Lateral Scler.* 8, 195-213 (2007)
90. Wijesekera LC, Leigh PN. Amyotrophic lateral sclerosis. *Orphanet J Rare Dis.* 4, 3 (2009)
91. Valdmanis PN, Rouleau GA. Genetics of familial amyotrophic lateral sclerosis. *Neurology.* 70, 144-152 (2008)
92. Chow TW, Miller BL, Hayashi VN, Geschwind DH. Inheritance of frontotemporal dementia. *Arch Neurol.* 56, 817-822 (1999)
93. Phukan J, Pender NP, Hardiman O. Cognitive impairment in amyotrophic lateral sclerosis. *Lancet Neurol.* 6, 994-1003 (2007)
94. Kato S. Amyotrophic lateral sclerosis models and human neuropathology: similarities and differences. *Acta Neuropathol.* 115, 97-114 (2008)
95. Mackenzie IR, Bigio EH, Ince PG et al. Pathological TDP-43 distinguishes sporadic amyotrophic lateral sclerosis from amyotrophic lateral sclerosis with SOD1 mutations. *Ann Neurol.* 61, 427-434 (2007)
96. Maekawa S, Leigh PN, King A et al. TDP-43 is consistently co-localized with ubiquitinated inclusions in sporadic and Guam amyotrophic lateral sclerosis but not in familial amyotrophic lateral sclerosis with and without SOD1 mutations. *Neuropathology.* (2009)
97. Tan CF, Eguchi H, Tagawa A et al. TDP-43 immunoreactivity in neuronal inclusions in familial amyotrophic lateral sclerosis with or without SOD1 gene mutation. *Acta Neuropathol.* 113, 535-542 (2007)

98. Al-Chalabi A, Fang F, Hanby MF et al. An estimate of amyotrophic lateral sclerosis heritability using twin data. *J Neurol Neurosurg Psychiatry*. 81, 1324-1326 (2010)
99. Rosen DR, Siddique T, Patterson D et al. Mutations in Cu/Zn superoxide dismutase gene are associated with familial amyotrophic lateral sclerosis. *Nature*. 362, 59-62 (1993)
100. Kunst CB. Complex genetics of amyotrophic lateral sclerosis. *Am J Hum Genet*. 75, 933-947 (2004)
101. Valdmanis PN, Daoud H, Dion PA, Rouleau GA. Recent advances in the genetics of amyotrophic lateral sclerosis. *Curr Neurol Neurosci Rep*. 9, 198-205 (2009)
102. Gellera C, Ticozzi N, Pensato V et al. ATAXIN2 CAG-repeat length in Italian patients with amyotrophic lateral sclerosis: risk factor or variant phenotype? Implication for genetic testing and counseling. *Neurobiol Aging*. (2012)
103. Lee T, Li YR, Ingre C et al. Ataxin-2 intermediate-length polyglutamine expansions in European ALS patients. *Hum Mol Genet*. 20, 1697-1700 (2011)
104. Andersen PM, Al-Chalabi A. Clinical genetics of amyotrophic lateral sclerosis: what do we really know? *Nat Rev Neurol*. 7, 603-615 (2011)
105. Millicamps S, Salachas F, Cazeneuve C et al. SOD1, ANG, VAPB, TARDBP, and FUS mutations in familial amyotrophic lateral sclerosis: genotype-phenotype correlations. *J Med Genet*. (2010)
106. Bruijn LI, Houseweart MK, Kato S et al. Aggregation and motor neuron toxicity of an ALS-linked SOD1 mutant independent from wild-type SOD1. *Science*. 281, 1851-1854 (1998)
107. Buratti E, Baralle FE. The molecular links between TDP-43 dysfunction and neurodegeneration. *Adv Genet*. 66, 1-34 (2009)
108. Strong MJ, Volkening K, Hammond R et al. TDP43 is a human low molecular weight neurofilament (hNFL) mRNA-binding protein. *Mol Cell Neurosci*. 35, 320-327 (2007)
109. Ayala YM, Zago P, D'Ambrogio A et al. Structural determinants of the cellular localization and shuttling of TDP-43. *J Cell Sci*. 121, 3778-3785 (2008)
110. Buratti E, Dork T, Zuccato E et al. Nuclear factor TDP-43 and SR proteins promote in vitro and in vivo CFTR exon 9 skipping. *EMBO J*. 20, 1774-1784 (2001)
111. Amador-Ortiz C, Lin WL, Ahmed Z et al. TDP-43 immunoreactivity in hippocampal sclerosis and Alzheimer's disease. *Ann Neurol*. 61, 435-445 (2007)
112. Arai T, Mackenzie IR, Hasegawa M et al. Phosphorylated TDP-43 in Alzheimer's disease and dementia with Lewy bodies. *Acta Neuropathol*. 117, 125-136 (2009)
113. Higashi S, Iseki E, Yamamoto R et al. Concurrence of TDP-43, tau and alpha-synuclein pathology in brains of Alzheimer's disease and dementia with Lewy bodies. *Brain Res*. 1184, 284-294 (2007)
114. Igaz LM, Kwong LK, Lee EB et al. Dysregulation of the ALS-associated gene TDP-43 leads to neuronal death and degeneration in mice. *J Clin Invest*. 121, 726-738 (2011)
115. Stallings NR, Puttaparthi K, Luther CM et al. Progressive motor weakness in transgenic mice expressing human TDP-43. *Neurobiol Dis*. 40, 404-414 (2010)
116. Wegorzewska I, Bell S, Cairns NJ et al. TDP-43 mutant transgenic mice develop features of ALS and frontotemporal lobar degeneration. *Proc Natl Acad Sci U S A*. 106, 18809-18814 (2009)
117. Wils H, Kleinberger G, Janssens J et al. TDP-43 transgenic mice develop spastic paralysis and neuronal inclusions characteristic of ALS and frontotemporal lobar degeneration. *Proc Natl Acad Sci U S A*. 107, 3858-3863 (2010)
118. Dormann D, Capell A, Carlson AM et al. Proteolytic processing of TAR DNA binding protein-43 by caspases produces C-terminal fragments with disease defining properties independent of progranulin. *J Neurochem*. 110, 1082-1094 (2009)



- 119.** Kleinberger G, Wils H, Ponsaerts P et al. Increased caspase activation and decreased TDP-43 solubility in progranulin knockout cortical cultures. *J Neurochem.* 115, 735-747 (2010)
- 120.** Zhang YJ, Xu YF, Dickey CA et al. Progranulin mediates caspase-dependent cleavage of TAR DNA binding protein-43. *J Neurosci.* 27, 10530-10534 (2007)
- 121.** Hasegawa M, Arai T, Nonaka T et al. Phosphorylated TDP-43 in frontotemporal lobar degeneration and amyotrophic lateral sclerosis. *Ann Neurol.* 64, 60-70 (2008)
- 122.** Sephton CF, Good SK, Atkin S et al. TDP-43 is a developmentally regulated protein essential for early embryonic development. *J Biol Chem.* 285, 6826-6834 (2009)
- 123.** Brooks BR. El Escorial World Federation of Neurology criteria for the diagnosis of amyotrophic lateral sclerosis. Subcommittee on Motor Neuron Diseases/Amyotrophic Lateral Sclerosis of the World Federation of Neurology Research Group on Neuromuscular Diseases and the El Escorial "Clinical limits of amyotrophic lateral sclerosis" workshop contributors. *J Neurol Sci.* 124 Suppl, 96-107 (1994)
- 124.** Nagasaka Y, Dillner K, Ebise H et al. A unique gene expression signature discriminates familial Alzheimer's disease mutation carriers from their wild-type siblings. *Proc Natl Acad Sci U S A.* 102, 14854-14859 (2005)
- 125.** Mukherjee O, Wang J, Gitcho M et al. Molecular characterization of novel progranulin (GRN) mutations in frontotemporal dementia. *Hum Mutat.* 29, 512-521 (2008)
- 126.** Basun H, Almkvist O, Axelman K et al. Clinical characteristics of a chromosome 17-linked rapidly progressive familial frontotemporal dementia. *Arch Neurol.* 54, 539-544 (1997)
- 127.** Froelich S, Basun H, Forsell C et al. Mapping of a disease locus for familial rapidly progressive frontotemporal dementia to chromosome 17q12-21. *Am J Med Genet.* 74, 380-385 (1997)
- 128.** Capell A, Liebscher S, Fellerer K et al. Rescue of progranulin deficiency associated with frontotemporal lobar degeneration by alkalizing reagents and inhibition of vacuolar ATPase. *J Neurosci.* 31, 1885-1894 (2011)
- 129.** Cenik B, Sephton CF, Dewey CM et al. Suberoylanilide hydroxamic acid (vorinostat) up-regulates progranulin transcription: rational therapeutic approach to frontotemporal dementia. *J Biol Chem.* 286, 16101-16108 (2011)